

Operating Instructions

SIRAX BT5700

Programmable transducer for heavy current variables



 **CAMILLE BAUER**

Camille Bauer Metrawatt AG
Aargauerstrasse 7
CH-5610 Wohlen/Switzerland

Tel: +41 56 618 21 11
Fax: +41 56 618 21 21

info@cbmag.com
www.camillebauer.com

Legal information

Warning notices

In this document warning notices are used, which you have to observe to ensure personal safety and to prevent damage to property. Depending on the degree of danger the following symbols are used:



If the warning notice is not followed death or severe personal injury **will** result.



If the warning notice is not followed damage to property or severe personal injury **may** result.



If the warning notice is not followed the device **may** be damaged or **may** not fulfill the expected functionality.

Qualified personnel

The product described in this document may be handled by personnel only, which is qualified for the respective task. Qualified personnel have the training and experience to identify risks and potential hazards when working with the product. Qualified personnel are also able to understand and follow the given safety and warning notices.

Intended use

The product described in this document may be used only for the application specified. The maximum electrical supply data and ambient conditions specified in the technical data section must be adhered. For the perfect and safe operation of the device proper transport and storage as well as professional assembly, installation, handling and maintenance are required.

Disclaimer of liability

The content of this document has been reviewed to ensure correctness. Nevertheless it may contain errors or inconsistencies and we cannot guarantee completeness and correctness. This is especially true for different language versions of this document. This document is regularly reviewed and updated. Necessary corrections will be included in subsequent version and are available via our webpage <http://www.camillebauer.com>.

Feedback

If you detect errors in this document or if there is necessary information missing, please inform us via e-mail to: customer-support@camillebauer.com

Table of content

1. Introduction	4
1.1 Purpose of this document	4
1.2 Scope of supply	4
1.3 Further documents	4
2. Safety notes	4
3. Device overview	5
3.1 Brief description	5
3.2 Available measurement data	5
4. Mechanical mounting	6
4.1 Mounting	6
4.2 Demounting of the device	6
5. Electrical connections	7
5.1 General safety notes	7
5.2 Cross sections and tightening torques	7
5.3 Inputs	8
5.4 Power supply	9
5.5 Connection diagram	9
5.6 Modbus interface RS485	9
6. Commissioning	9
6.1 Operating the device	10
6.2 Setup Parameter Screen	10
7. Programming	13
7.1. Password Protection	13
7.1.1 Change Password New / Change Password	14
7.2 Menu selection	15
7.2.1 System type selection	15
7.2.2 Potential Transformer primary Value	16
7.2.3 Current Transformer Primary Value	16
7.2.4 Current Transformer Secondary Value	17
7.2.5 Energy Display on modbus	17
7.2.6 RESET of parameters	18
7.2.7 Modbus Address	18
7.2.8 Auto scrolling	19
7.2.9 Start current Cutoff	19
7.2.10 Baud Rate	20
7.2.11 Parity and Stop bits	20
7.2.12 Energy rate	20
7.2.13 Energy digit reset count	21
8. Phasor Diagram	22
9. Programming via the RS485 (Modbus) interface	22
10. Service, maintenance and disposal	23
10.1 Repair work and modifications	23
10.2 Calibration and new adjustment	23
10.3 Cleaning	23
10.4 Disposal	23
10.5 Return	23
11. Technical data	24
12. Dimensional drawings	26
13. Interface Definition Modbus RTU	27
13.1 Modbus functions	27
13.2 Data types	27

1. Introduction

1.1 Purpose of this document

This document describes the universal measurement device SIRAX BT5700. It is intended to be used by:

- Installation personnel and commissioning engineers
- Service and maintenance personnel
- Planners

Scope

This handbook is valid for all hardware versions of the BT5700. Some of the functions described in this document are available only, if the necessary optional components are included in the device.

Required knowledge

A general knowledge in the field of electrical engineering is required. For assembly and installation of the device knowledge of applicable national safety regulations and installation standard is required.

1.2 Scope of supply

- Measurement device SIRAX BT5700
- Safety instructions (multiple languages)

1.3 Further documents

The following documents are provided electronically via www.camillebauer.com:

- Safety instructions SIRAX BT5700
- Operating Instructions SIRAX BT5700
- Data sheet SIRAX BT5700

2. Safety notes



Device may only be disposed in a professional manner!



The installation and commissioning should only be carried out by trained personnel.

Check the following points before commissioning:

- that the maximum values for all the connections are not exceeded, see „Technical data“ section,
- that the connection wires are not damaged, and that they are not live during wiring,
- that the power flow direction and the phase rotation are correct.

The instrument must be taken out of service if safe operation is no longer possible (e.g. visible damage). In this case, all the connections must be switched off. The instrument must be returned to the factory or to an authorized service dealer.

It is forbidden to open the housing and to make modifications to the instrument. The instrument is not equipped with an integrated circuit breaker. During installation check that a labeled switch is installed and that it can easily be reached by the operators.

Unauthorized repair or alteration of the unit invalidates the warranty.

3. Device overview

3.1 Brief description

The universal measuring device SIRAX BT5700 is suited for fixed mounting and the measurement of Voltage, current, frequency, power, energy (active / reactive / apparent), power factor, phase angle, etc in low voltage switchgear. The units are designed for unbalanced load network forms of 3-phase mains with 3- or 4-wire.

3.2 Available measurement data

Measured Parameters	Units	3P 3W	3P 4W
System Voltage U	V	•	•
Voltage U1N / U2N / U3N	V	–	•
Voltage U12 / U23 / U31	V	•	•
System Current I	A	•	•
Current I1 / I2 / I3	A	•	•
Neutral Current IN (calc.)	A	–	•
Frequency F	Hz	•	•
Active Power P / P1 / P2 / P3	kW	–	•
Reactive Power $\varnothing Q$ / Q1 / Q2 / Q3	kVAr	–	•
Apparent Power $\varnothing S$ / S1 / S2 / S3	kVA	–	•
Power Factor PF1 / PF2 / PF3	–	–	•
Phase Angle Phi1 / Phi2 / Phi3	degree	–	•
Active Import Energy (8 Digit resolution)	kWh	•	•
Active Export Energy (8 Digit resolution)	kWh	•	•
Capacitive Reactive Energy (8 Digit resolution)	kVArh	•	•
Inductive Reactive Energy (8 Digit resolution)	kVArh	•	•
Apparent Energy (8 Digit resolution)	kVAh	•	•
Max Current Demand	A	•	•
Apparent Power Demand	kVA	•	•
Min / Max System Voltage	V	•	•
Min / Max System Current	A	•	•

4. Mechanical mounting

The SIRAX BT5700 is designed for panel mounting.



Please ensure that the operating temperature limits are not exceeded when determining the place of mounting (place of measurement): **-10 ... +55° C**

4.1 Mounting

Dimensional drawing BT5700: See section 11

Any mounting position is possible. Device may be clipped onto a top-hat rail according EN50022 in a cabinet.

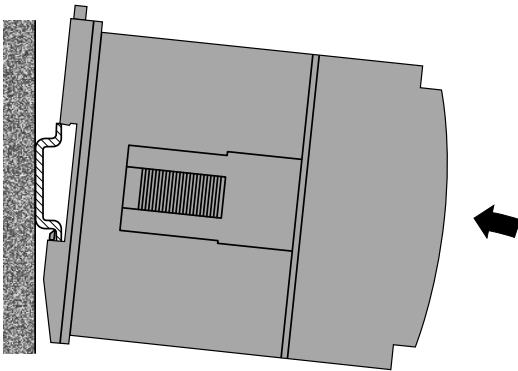

4.2 Demounting of the device

Disassembly of the device requires that all connected wires be without current. First, remove all push terminals and the wires of the current and voltage inputs. Ensure that possible current transformers are short-circuited before the current connections on the device are opened.

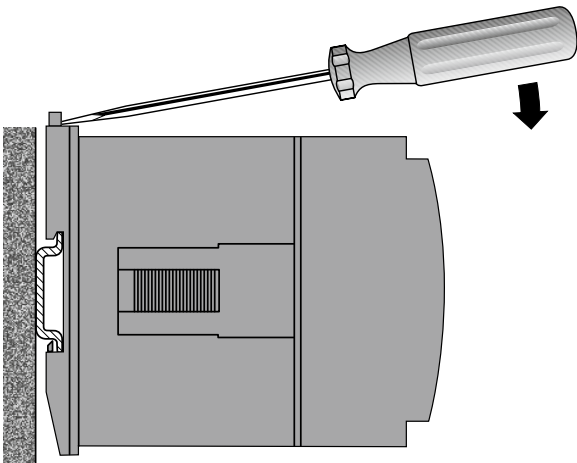

5. Electrical connections



Ensure under all circumstances that the leads are free of potential when connecting them!

5.1 General safety notes



Please observe that the data on the type plate must be adhered to!

The national provisions have to be observed in the installation and material selection of electric lines!

Symbol	Meaning
	Device may only be disposed of in a professional manner!
	Double insulation, device of protection class 2
CAT III	Measurement category CAT III for current / voltage inputs, power supply and relay outputs
	CE conformity mark. The device fulfills the requirements of the applicable EC directives. See declaration of conformity.
	Caution! General hazard point. Read the operating instructions.
	Attention: Danger to life!
	Please note

5.2 Cross sections and tightening torques

Terminals 1 ... 14

Single wire: $\leq 4,0\text{mm}^2$ or multiwire with end splices: $2 \times 2,5\text{mm}^2$

Torque: 0.5 ... 0.6Nm resp. 4.42 ... 5.31 lbf in

Terminal A, B, G

Single wire: $\leq 1,5\text{mm}^2$ or multiwire with end splices: $2 \times 0,5\text{mm}^2$

Torque: max. 0.5 Nm resp. 4.42 lbf in

5.3 Inputs



All voltage measurement inputs must originate at circuit breakers or fuses rated by 1 Amps. This does not apply to the neutral connector. You have to provide a method for manually removing power from the device, such as a clearly labeled circuit breaker or a fused disconnect switch.

When using **voltage transformers** you have to ensure that their secondary connections never will be short-circuited.



No fuse may be connected upstream of the **current measurement inputs!**

When using **current transformers** their secondary connectors must be short-circuited during installation and before removing the device. Never open the secondary circuit under load.

The connection of the inputs depends on the configured system (connection type).

5.4 Power supply



A marked and easily accessible current limiting switch has to be arranged in the vicinity of the device for turning off the power supply. Fusing should be 10 Amps or less and must be rated for the available voltage and fault current.

5.5 Connection diagram

Three wire, three phase system, unbalanced load, Aron connection (3P 3W)

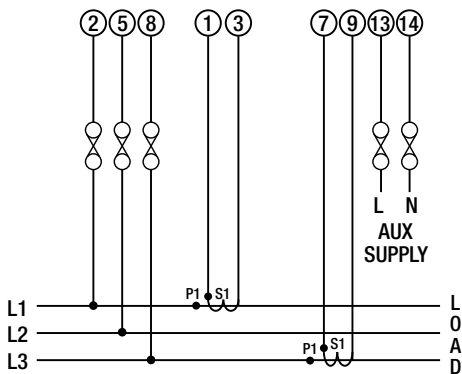

Direct connection

Four wire, three phase system, unbalanced load (3P 4W)

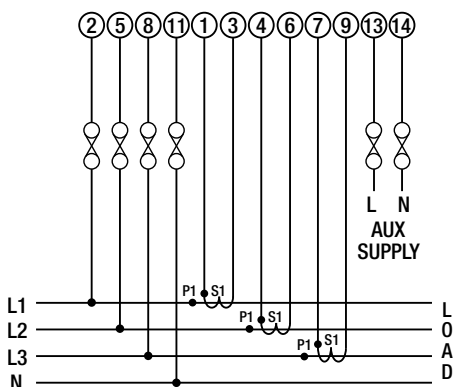

Direct connection



5.6 Modbus interface RS485

Via the optional Modbus interface measurement data may be provided for a superior system.

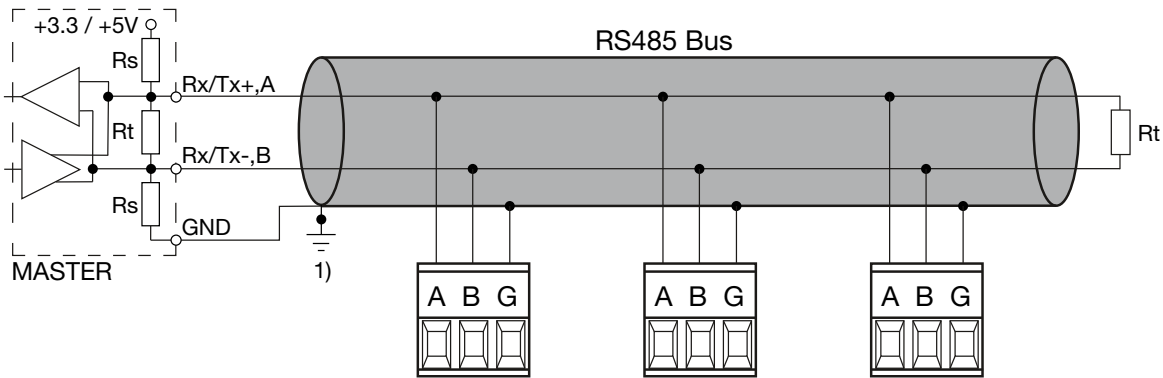

1) One ground connection only. This is possibly made within the master (PC).

Rt: Termination resistors: 120 Ω each for long cables (> approx. 10 m)

Rs: Bus supply resistors, 390 Ω each

The signal wires (A, B) have to be twisted. GND (G) can be connected via a wire or via the cable screen. In disturbed environments shielded cables must be used. Supply resistors (Rs) have to be present in bus master (PC) interface. Stubs should be avoided when connecting the devices. A pure daisy chain network is ideal.

You may connect up to 32 Modbus devices to the bus. A proper operation requires that all devices connected to the bus have equal communication settings (baud rate, transmission format) and unique Modbus addresses.

The bus system is operated half duplex and may be extended to a maximum length of 1200 m without repeater.

6. Commissioning



Before commissioning you have to check if the connection data of the device match the data of the plant.
If so, you can start to put the device into operation by switching on the power supply and the measurement inputs.

SIRAX BT5700		
ORDER CODE: 175275		
SR No.: 15/11/0001		
CLASS: 0.5	CAT III 300V Max.	V40.05
INPUT: 3PH. 440 V L - L, 5A/1A, 45...65Hz		
OPTION: RS485		
AUXILIARY: 12...48V DC, 4VA		

Label version RS485
(Article-Nr. 175 275)

SIRAX BT5700		
ORDER CODE: 175134		
SR No.: 15/11/0001		
CLASS: 0.5	CAT III 300V Max.	V40.05
INPUT: 3PH. 440 V L - L, 5A/1A, 45...65Hz		
OPTION: RS485		
AUXILIARY: 100...250V AC/DC, 4VA		

Label version RS485
(Article-Nr. 175 134)

6.1 Operating the device



SIRAX BT5700 can be configured and programmed at site for the following: PT Primary, CT Primary, CT Secondary (5A or 1A) & three wire, three phase system or four wire, three phase system. The front panel has two push buttons through which the User may scroll through the available measurement readings, reset the energy (Import/Export) Min/Max (System Voltage & System Current) & configure the product.

Operation is performed by means of 2 keys:

2 keys “ UP” and “ DOWN” for navigation and for the selection of values.

6.2 Setup Parameter Screen

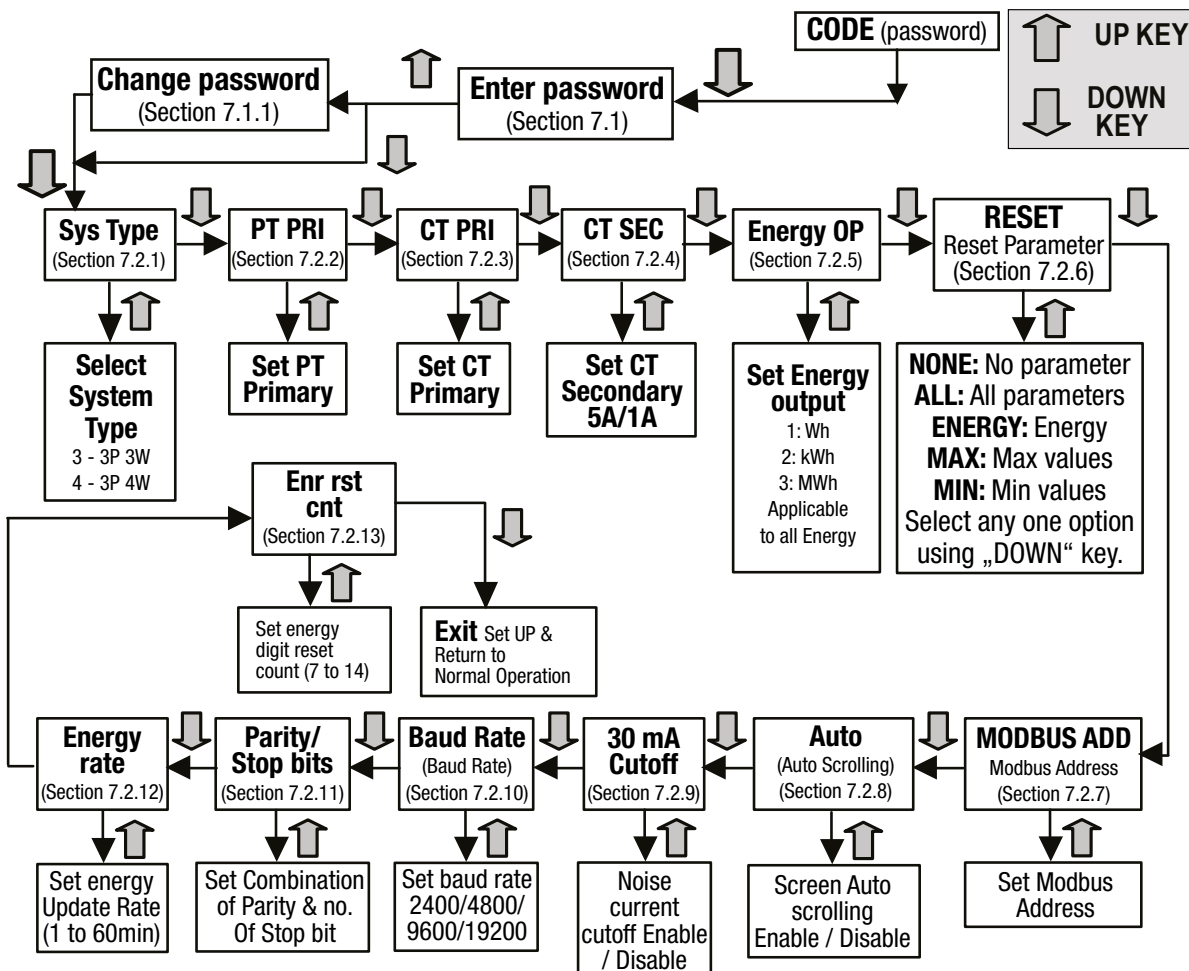

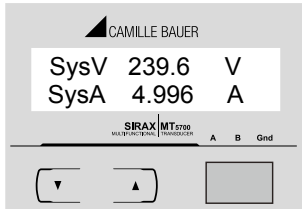

Screen 1: System screen (U, I)

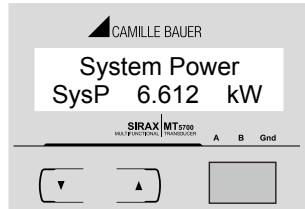

Screen 2: System Power (P)

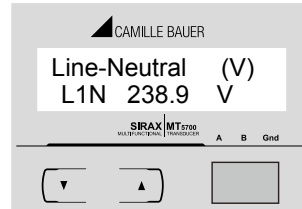

Screen 3: Line to neutral Voltage (VL1N) (4 Wire only)

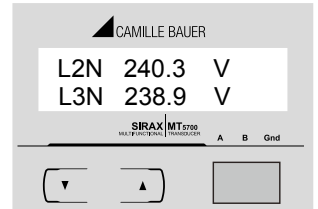

Screen 4: Line to neutral Voltage (U2N, U3N) (4 Wire only)

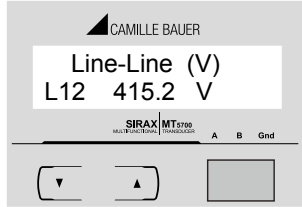

Screen 5: Line to line Voltage (U12)

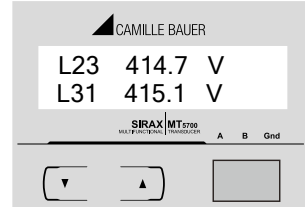

Screen 6: Line to line (U23, U31) Voltage

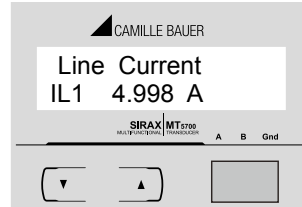

Screen 7: Line Current (I1)

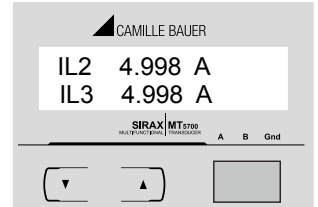

Screen 8: line Currents (I2, I3)

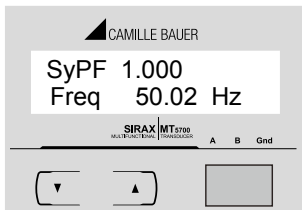

Screen 9: System Power factor, Frequency (Pf, F)

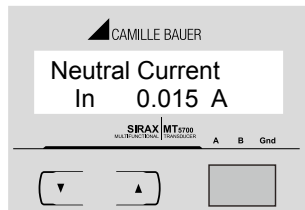

Screen 10: Neutral Current (IN) (4 Wire only)

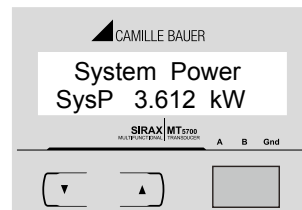

Screen 11: System Active Power (P)

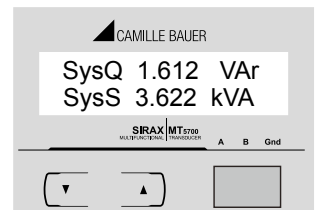

Screen 12: System Powers (Q, S)

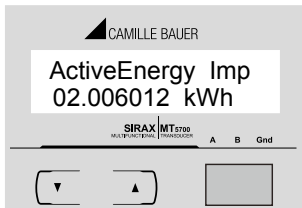

Screen 13: Active Energy ($\int P_{inc}$)

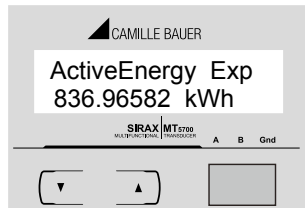

Screen 14: Active energy ($\int P_{out}$)

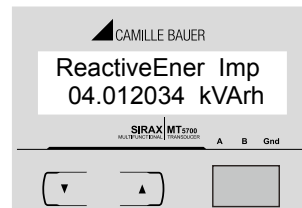

Screen 15: Reactive Energy ($\int Q_{inc}$)

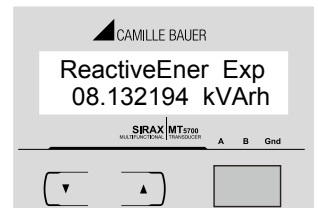

Screen 16: Reactive energy ($\int Q_{out}$)

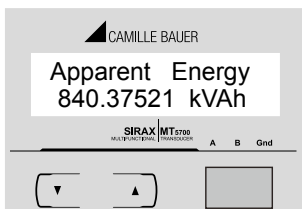

Screen 17: Apparent energy ($\int S$)

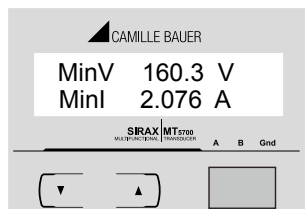

Screen 18: Min values (Umin, Umax)

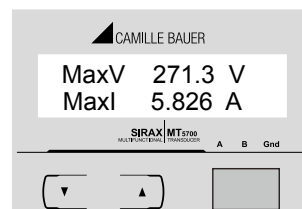

Screen 19: Max values (Umin, Umax)

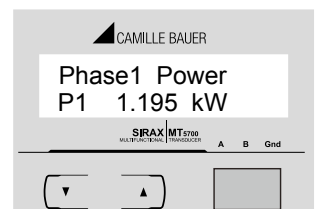

Screen 20: Phase 1 Active Power (P1) (4 Wire only)

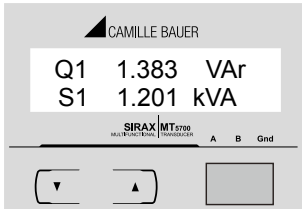

Screen 21: Phase 1 Power (Q1, S1) (4 wire only)

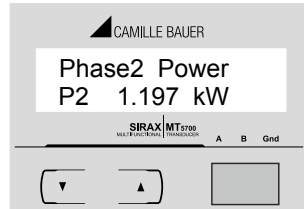

Screen 22: Phase 2 Active Power (P2) (4 wire only)

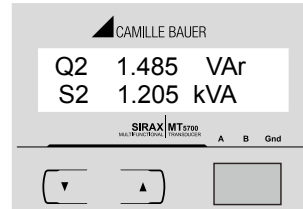

Screen 23: Phase 2 Power (Q2, S2) (4 wire only)

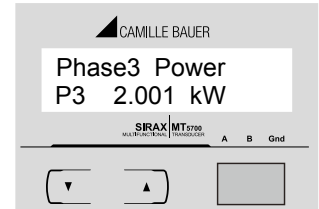

Screen 24: Phase 3 Power Active (P3) (for 4 Wire only)

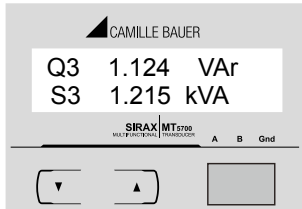

Screen 25: Phase 3 Power (Reactive/Apparent) (Q3, S3) (4wire only)

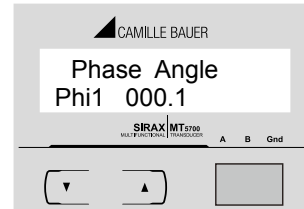

Screen 26: Phase angle (phase 1) (Phi1) (for 4 Wire only)

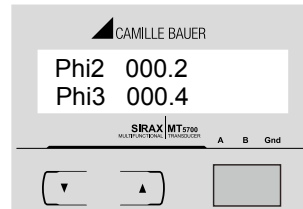

Screen 27: Phase angle (phase 2, 3) (Phi 2, Phi 3) (for 4 Wire only)

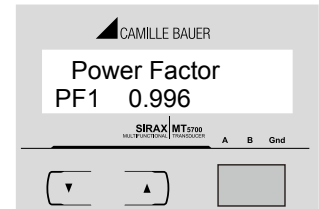

Screen 28: Power factor (phase 1) (PF) (for 4 Wire only)

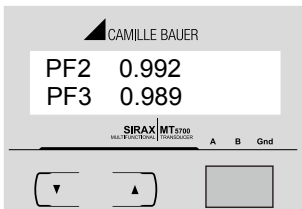

Screen 29: Power factor (phase 2, 3) (PF2, PF3) (for 4 Wire only)

7. Programming

The following sections comprise step by step procedures for configuring the SIRAX BT5700 for individual user requirements. To access the set-UP screens, press and hold the “**DOWN**” and “**UP**” Key simultaneously for 5 seconds. This will take the User into the Password Protection Entry Stage (Section 7.1).

7.1. Password Protection

Password protection can be enabled to prevent unauthorised access to set-UP screens, by default password protection is not enabled. Password protection is enabled by selecting a digit number other than 0000, setting a password of 0000 disables the password protection.

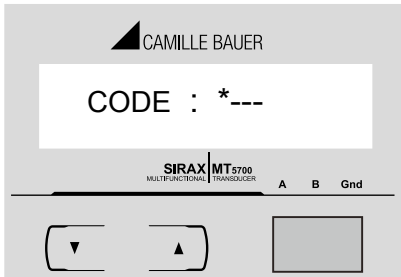

Enter Password, prompt for first digit. (*Denotes that the digit will be flashing.
Press “ (DOWN) ” key to scroll the value of the first digit From 0 through 9, the value will wrap from 9 round to 0. Press “UP ” key to advance to next digit.
In the special case, where password is “0000”, pressing the “UP” key when prompted for first digit will advance to the password “confirmed” screen.

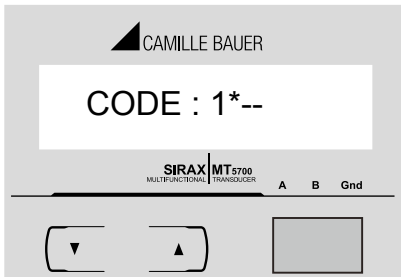

Enter Password, first digit entered, prompt for second digit. (*Denotes that the digit will be flashing).
Press “(DOWN) ” key to scroll the value of the first digit From 0 through 9, the value will wrap from 9 round to 0. Press “UP” key to advance to next digit.

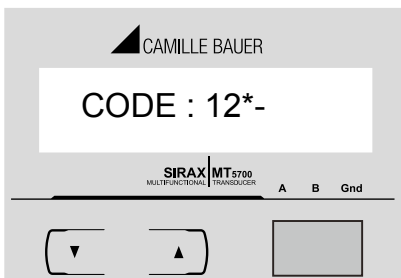

Enter Password, second digit entered, prompt for third digit. (*Denotes that the digit will be flashing.
Press “ DOWN ” key to scroll the value of the first digit From 0 through 9, the value will wrap from 9 round to 0.
Press “UP ” key to advance to next digit.

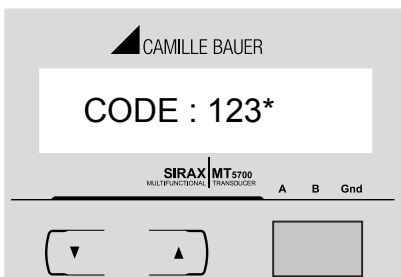

Enter Password, third digit entered, prompt for fourth digit. (* Denotes that digit will be flashing).
Use the “DOWN” key to scroll the value of the fourth digit from 0 through to 9, the value will wrap from 9 round to 0.
Press the “UP” key to advance to verification of the password.

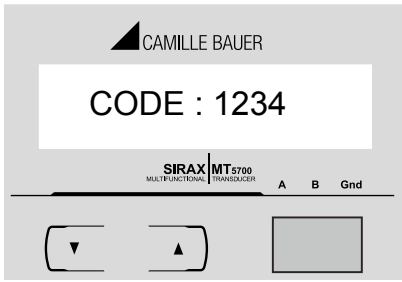

Enter Password, fourth digit entered, awaiting verification of the password.

Password confirmed

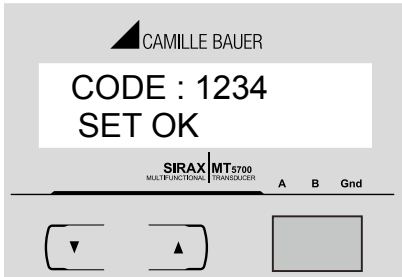

Pressing "DOWN" key will advance to the "New/change Password" entry stage (section 7.1.1)
Pressing the "UP" key will advance to the Menu selection screen. (See section 7.2).

Password Incorrect

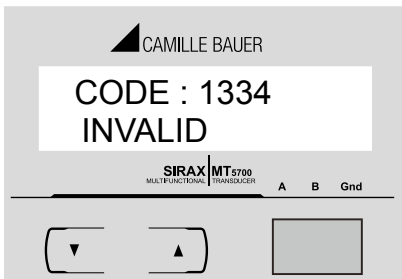

The unit has not accepted the Password entered. Pressing the "DOWN" key will return to the Enter Password stage.
Pressing the "UP" key exits the Password menu & returns operation to the measurement reading mode.

7.1.1 Change Password New / Change Password

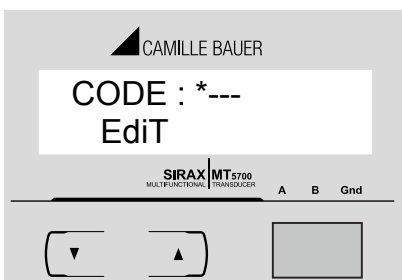

(* indicates that this digit will be flashing).
Pressing the "DOWN" key will scroll the value of the first digit from 0 through to 9, the value will wrap from 9 round to 0. Pressing the "UP" key to advance the operation to the next digit & sets the first digit, in this case "2".

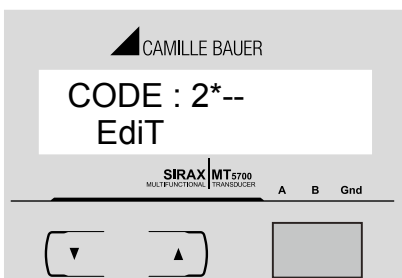

New / Change Password, first digit entered, prompting for second digit. (* indicates that this digit will be flashing).
Pressing the "DOWN" key will scroll the value of the second digit from 0 through to 9, the value will wrap from 9 round to 0.
Pressing the "UP" key to advance the operation to the next digit and sets the second digit, in this case to "3".

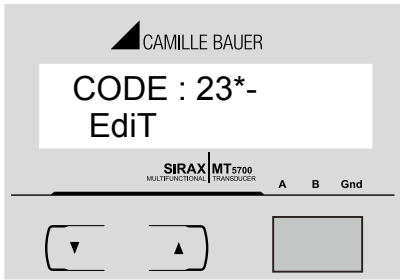

New / Change Password, second digit entered, prompting for third digit. (* indicates that this digit will be flashing).
 Pressing the “DOWN” key will scroll the value of the third digit from 0 through to 9, the value will wrap from 9 round to 0.
 Pressing the “UP” key to advance the operation to the next digit and sets the third digit, in this case to “4”

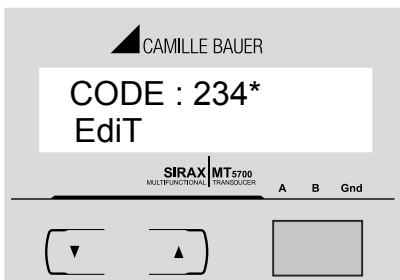

New / Change Password, third digit entered, prompting for fourth digit. (* indicates that this digit will be flashing).
 Pressing the “DOWN” key will scroll the value of the fourth digit from 0 through to 9, the value will wrap from 9 round to 0.
 Pressing the “UP” key to advance the operation to the next digit and sets the fourth digit, in this case to “5”

New Password confirmed

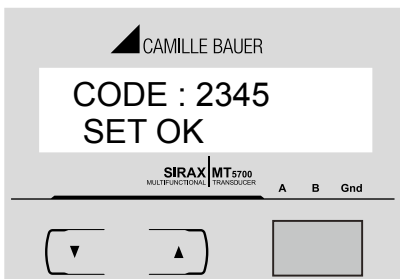

Pressing the “DOWN” key will return to the “New/Change Password”.
 Pressing the “UP” key will advances to the system type Selection screen. (see section 7.2.1).

7.2 Menu selection

7.2.1 System type selection

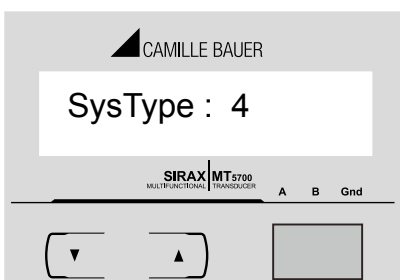

This screen is used to set the system type.
 System type “3” for 3 phase 3 wire & “4” for 3 phase 4 wire system. Pressing “UP” key accepts the present value and advances to the “Potential transformer Primary value edit menu 7.2.2
 Pressing “DOWN” key will enter system type Edit mode and scroll between 3 and 4.
 Pressing “UP” key advances to the system type confirmation menu.

System Type Conformation

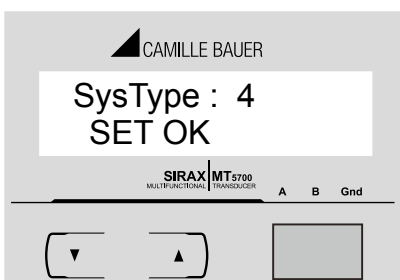

Pressing “UP” sets the displayed value and will advance to “Potential Transformer Primary Value Edit” menu. (See section 7.2.2)
 Pressing “DOWN” key will return to the system type “Edit” menu.

7.2.2 Potential Transformer primary Value

The nominal full scale voltage which will be displayed as Line to Line voltage in four wire or 3 wire system. The value represent the voltage in kVLL.

Maximum Potential transformer primary value can be set to 692.8 kVLL or restricted to 666 MVA depends on previously set Current transformer (CT) primary value. The minimum value allowed is 100VLL.

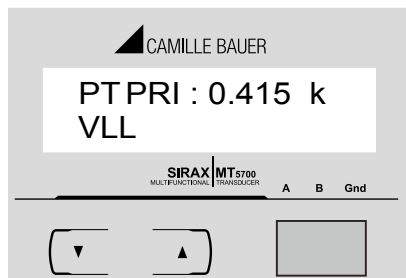

Pressing "UP" key accepts the present value and then advances to Current transformer (CT) Primary value edit menu (section 7.2.3). Pressing "DOWN" key enters into "Potential Transformer Primary Value Edit" mode.

Initially the multiplier must be selected. Pressing the "DOWN" key will move the decimal point position to the right unit it reaches # # # . # after which it will return to # # # #.

Pressing "UP" key selects the present multiplier (decimal point position) and advances to the "potential Transformer primary digit Edit" mode.

Potential Transformer Primary Digit edit

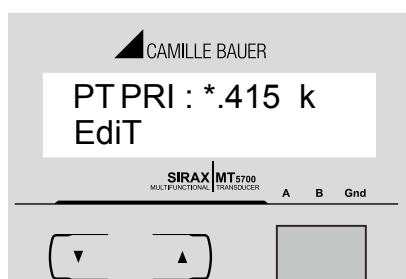

(* denotes that the digit will be flashing)

Pressing the "DOWN" key will scroll the value of the most significant digit from 0 through to 9 unless the presently displayed Potential Transformer Primary Value together with the Current Transformer Primary Value, previously set, would result in maximum power of greater than 666MVA per phase, in which case the digit range will be restricted.

Pressing "UP" key accepts the present value at the cursor position and advances the cursor to the next less significant digit.

When the least significant digit has been set, pressing "DOWN" key will advance to the "Potential Transformer Primary Value Confirmation" stage.

Potential transformer Primary value Confirmation



If scaling is to be corrected, pressing "DOWN" key will return to the "Potential Transformer Primary Value Edit" stage with the digits flashing indicating that the multiplier (decimal point position) should be selected. Pressing "UP" key sets the displayed value and then it will advance to Current transformer Primary Value selection menu (section 7.2.3).

7.2.3 Current Transformer Primary Value

The nominal Full Scale Current that will be displayed as the Line currents. This screen enables the user to display the Line currents inclusive of the transformer ratios, the values displayed represent the Current in Amps.

Maximum Current transformer primary value can be set to 9999 A or restricted to 666 MVA depends on previously set Potential transformer (PT) Primary value.

Pressing "UP" key accepts the present value and advances to the Current transformer Secondary value menu (section 7.2.4)

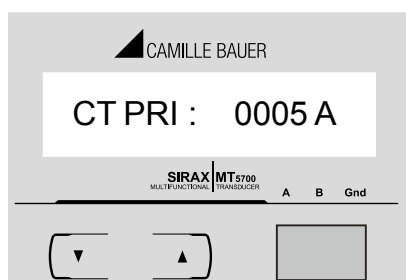

Pressing "DOWN" key will enter the "Current transformer Transformer Primary Value Edit" mode. This will scroll the value of the most significant digit from 0 through to 9, unless the presently displayed Current Transformer Primary Value together with the Potential Transformer Primary Value results in a maximum power of greater than 666MVA in which case the digit range will be restricted, the value will wrap.

Example:

If primary value of PT is set as 692.8 kVLL (max value) then primary value of Current is restricted to 1157A.

Pressing “UP” key will advance cursor to next less significant digit. (*Denotes that decimal point will be flashing).
 The Maximum Power restriction of 666 MVA refers to 120% of nominal current and 120% of Nominal voltage, i.e. 462.8MVA nominal power per phase.

When the least significant digit has been set, pressing “UP” key will advance to the “Current Transformer Primary Value Confirmation” stage.
 The minimum value allowed is 1, the value will be forced to 1 if the display contains zero

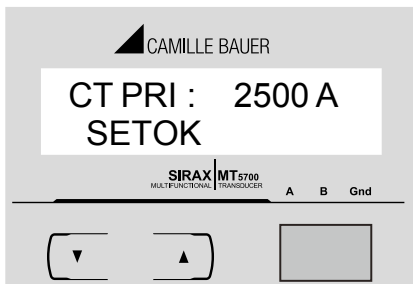

Current Transformer Primary value confirmation

If the set value is to be corrected, pressing “DOWN” key will re-enter the CT primary value edit stage.
 Pressing “UP” key, sets the displayed value as CT primary and advances to Current transformer Secondary menu (section 7.2.4).

7.2.4 Current Transformer Secondary Value

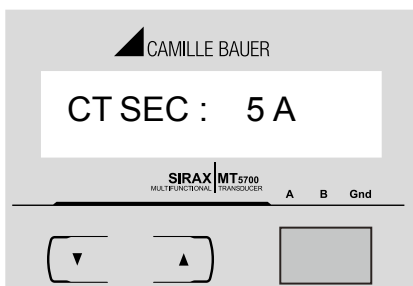

The screen is used to set the secondary value for Current Transformer.
 Pressing “UP” key accepts the present value and advances to Energy display on modbus menu. (section 7.2.5).
 Pressing “DOWN” key enters into CT secondary value Edit and scrolls the value between 1 and 5.
 After selecting the desired value, Pressing “UP” enters into CT secondary value confirmation screen.

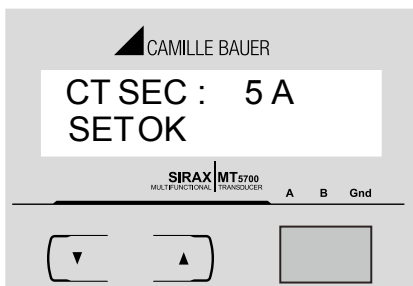

CT Secondary value confirmation

Pressing “DOWN” key reenters the CT secondary value edit menu.
 Pressing “UP” key sets the displayed value as CT secondary and advances to Energy display on modbus menu (section 7.2.5).

7.2.5 Energy Display on modbus

This screen enables user to set energy in terms of Wh / kWh / MWh on RS 485 Output depending as per the requirement. Same applicable for all types of energy.

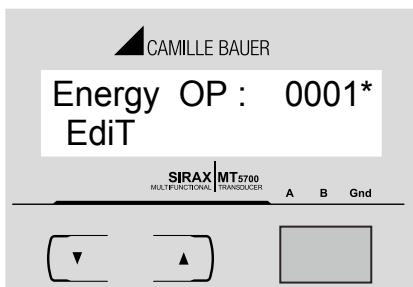

Pressing “UP” key accepts the present value and advances to the “Reset parameter” menu (See section 7.2.6).
 Pressing the “DOWN” key will enter the “Energy Display On Modbus Edit” mode and scroll the value through the values 1, 2 & 3 wrapping back to 1:
 1: Energy In Wh
 2: Energy in kWh
 3: Energy in MWh.
 Pressing the “UP” key advances to the “Energy Display On Modbus Confirmation” menu.

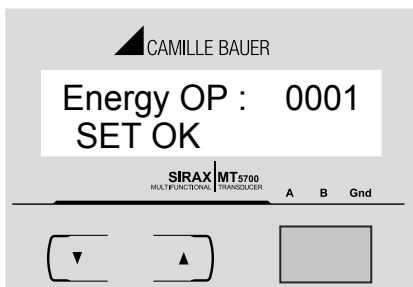

Energy Display On Modbus Confirmation.

This screen will only appear following an edit of the Energy Display On Modbus.
 Pressing the “DOWN” key will enter the “Energy Display On Modbus Edit” stage by blanking the bottom line of the display.
 Pressing “UP” key sets the displayed value and will advance to the “Reset parameter” menu. (See section 7.2.6)

Note: Default value is set to ‘2’ i.e. Energy on Modbus will be in terms of kWh/kVAh/kVAh resp.

7.2.6 RESET of parameters

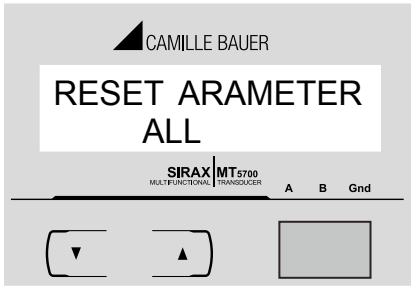

This screen is used to Reset the different parameters .

Pressing "UP" key resets the displayed parameters and advances to modbus address menu (section 7.2.7).

Pressing "DOWN" key scrolls the parameters to Reset From None, Energy, Min, Max, All and back to None.

Select the parameters which is to be Reset with "DOWN" Key. To reset the selected parameter press "UP" key.

After pressing "UP" key, it acknowledges the reset of parameter with "DONE" on display as shown.

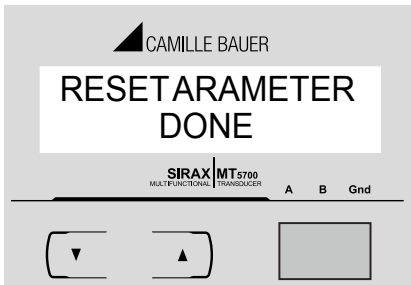

Further if another parameter is to be reset, press "DOWN" Key to scroll the parameter again.

Pressing "UP" key after DONE message displayed, advances the operation to modbus address menu. (Section 7.2.7)

7.2.7 Modbus Address

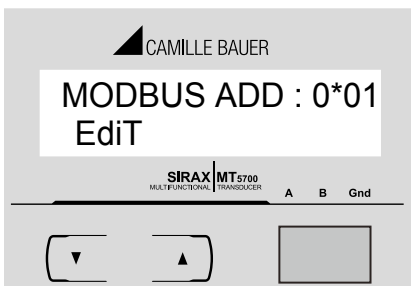

This screen allows the user to set device address of instrument for RS 485 communication. The range of allowable address is 1 to 247. Pressing "DOWN" key enters into the Modbus Address edit mode.

Enter Address, prompt for first digit.

* denotes that the Digit will be flashing.

Pressing "DOWN" key scrolls the value of flashing digit from 0 to 2 and back to 0.

Pressing "UP" key changes the cursor position to next Less significant digit.

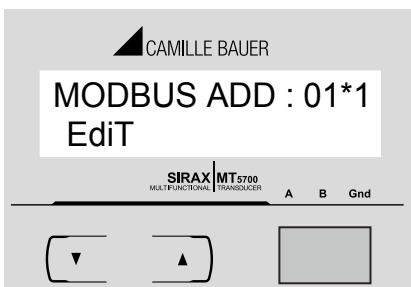

Enter Address, first digit entered, prompt for second digit

* denotes that the Digit will be flashing.

Pressing "DOWN" key scrolls the value of flashing digit from 0 to 9 and back to 0.

Pressing "UP" key changes the cursor position to next Less significant digit.

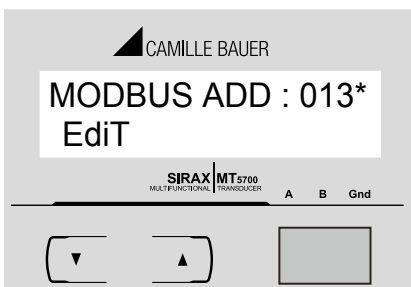

Enter address, second digit entered, prompt for third digit.

* denotes that the Digit will be flashing.

Pressing "DOWN" key scrolls the value of flashing digit from 0 to 9 and back to 0.

Pressing "UP" key enters the modbus address Confirmation screen.

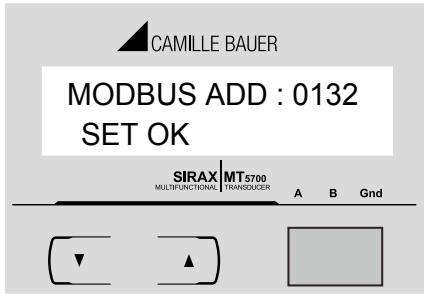

Modbus address Confirmation

Pressing "UP" key sets the modbus address & enters Into Auto scrolling selection menu (section 7.2.8).
Pressing "DOWN" key re-enters into Modbus address Setting menu.

7.2.8 Auto scrolling

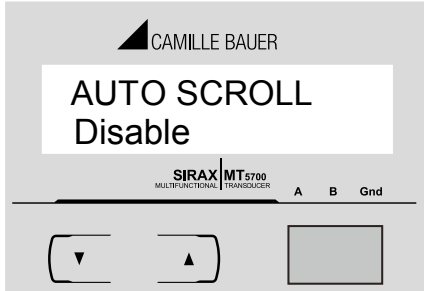

This screen allows user to enable screen scrolling.

Auto scrolling Edit.

Pressing "DOWN" key scrolls between enable and disable. Select enable for Auto scrolling of screen and select Disable for fixed screen.
Pressing "UP" key enters into Auto scrolling Confirmation screen

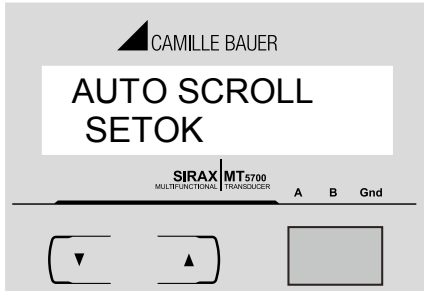

Auto Scrolling Confirmation

Pressing "UP" key, sets the selected option and advances to noise current cutoff menu (section 7.2.9)
Pressing "DOWN" key re-enters the auto scroll menu.

7.2.9 Start current Cutoff

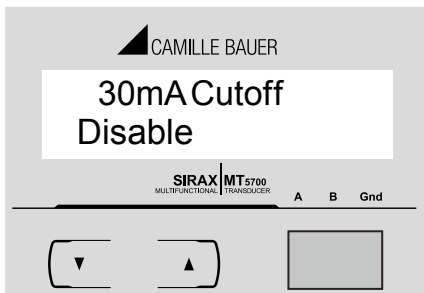

This screen allows user to set low start current cutoff at 30mA. Pressing "DOWN" key enters into edit mode and scrolls between Enable and disable.
Pressing "UP" key accepts the selected option and enters Into 30mA cutoff confirmation screen.

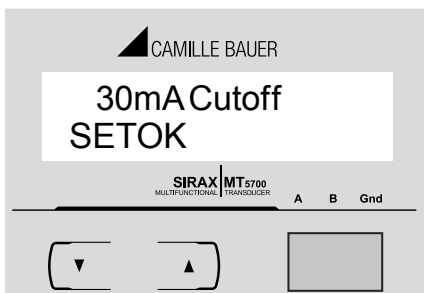

30mA cutoff confirmation

Pressing "UP" key sets the selected option and advances to Baud rate selection menu (section 7.2.10).
Pressing "DOWN" key re-enters into 30mA cutoff selection menu.

7.2.10 Baud Rate

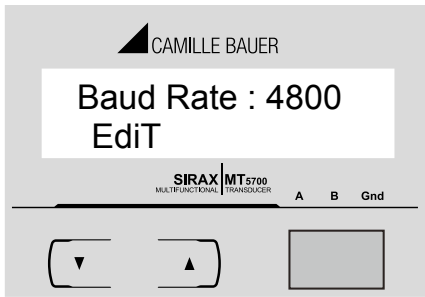

This screen allows user to set the baud rate for Rs485 communication. Pressing “UP” key sets the present value and advances to Parity and stop bits menu (Section 7.2.11). Pressing “DOWN” key enters into Baud rate Edit mode & scrolls The values from 2400, 4800, 9600 to 19200 & Back to 2400.

Pressing ‘UP’ key will advance to baud rate Confirmation screen.

Baud rate Confirmation

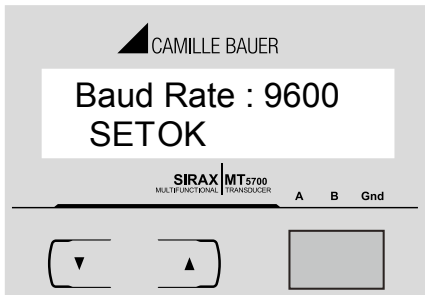

Pressing “DOWN” keys re-enters into baud rate edit mode. Pressing “UP” key sets the displayed value as baud rate and advances the operation to parity and stop bit menu (section 7.2.11).

7.2.11 Parity and Stop bits

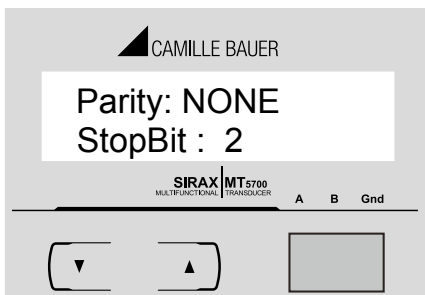

This menu allows user to set parity and number of stop bits for Rs485 communication interface.

The parity and number of stop bits are to be set in same menu.

Pressing “UP” key sets the displayed combination of Parity and stop bits and advances the operation to Energy rate selection menu (section 7.2.12).

Pressing “DOWN” key enters into edit mode and scrolls the Combination from Parity: None Stop bit:1, Parity: None Stop bit: 2

Parity: Even Stop bit: 1, Parity: Odd Stop bit:1 and back to Parity: None Stop bit: 1. After selecting the desired combination, pressing “UP” Key enters into parity and number of stop bit confirmation screen.

Parity and number of stop bit confirmation.

Parity and number of stop bit confirmation



Pressing “DOWN” key re-enters into the Parity and stop bit Edit menu.

Pressing “UP” key, sets the displayed values and advances the operation to Energy rate selection menu. (section 7.2.12).

7.2.12 Energy rate

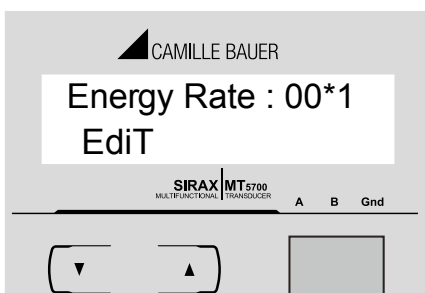

This menu allows user to set the energy reading Update rate from 1 to 60 minutes.

Pressing “DOWN” key enters into energy rate edit menu and scrolls the value of 10s digit from 0 to 6. If 1st digit is greater than 0 then 10s digit will wrap back to 0 from 5.

* denotes that the digit will be flashing.

Pressing “UP” key shifts the cursor position from 10s digit to 1s digit. Value of 1st digit scrolls from 0 to 9 and again Wraps back to 0.

After setting desired value of 1s digit pressing “UP” key Enters into energy rate confirmation screen.

Energy rate confirmation

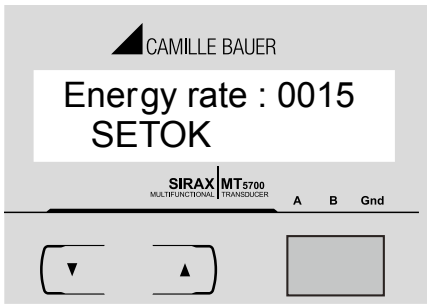

Pressing "DOWN" key re-enters into energy rate edit menu.
Pressing "UP" key sets the displayed value as energy update rate and then advance the operation to Energy digit reset count menu (section 7.2.13).
If energy rate is set to "00", then it sets "01" min as default value.

7.2.13 Energy Digit reset count

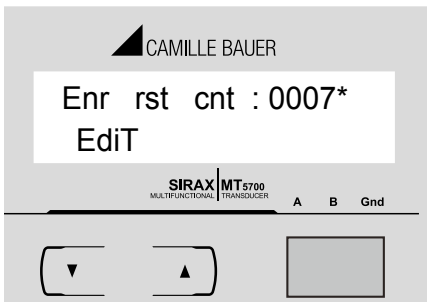

This screen enables user for setting maximum energy count after which energy will rollback to zero depends upon setting of Wh, kWh, & MWh.
Pressing the "UP" key sets the displayed value and then SIRAX BT5700 exits from setup menu and starts normal operation.
Pressing the "DOWN" key will enter the Energy digit reset count edit mode. This will scroll the value of reset count **from 7 to 14 for Wh, from 7 to 12 for KWh & from 7 to 9 for MWh.**

E.g. If energy display on modbus is set Wh & If you set Energy digit count to 10 then energy will reset after "9,999,999,999" & then will Rollback to zero. Pressing "UP" key will advance to Energy digit reset count confirmation screen.

Energy digit reset count confirmation

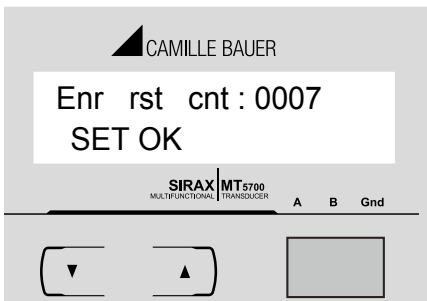

Pressing the "DOWN" key will re-enter Energy digit reset count edit mode.
Pressing the "UP" key sets the displayed value and will exits from setup menu and starts normal operation.

Note:

- 1) Default value is set to "8" i.e if energy count crosses 8 digit it will rollback to zero.
- 2) If Energy displays on modbus is set to (2: kWh) & energy digit reset count is set to 12. Energy screen on display will show "-----" i.e energy overflow when energy crosses the 11 digit count.....
- 3) If Energy displays on modbus is set to (3: MWh) & energy digit reset count is set to 9. Energy screen on display will show "-----" i.e energy overflow when energy crosses the 8 digit count.....

8. Phasor Diagram

- Quadrant 1:** 0° to 90°
- Quadrant 2:** 90° to 180°
- Quadrant 3:** 180° to 270°
- Quadrant 4:** 270° to 360°

In this diagram a technical visualization of the current and voltage phasors is shown, using a clockwise rotation.

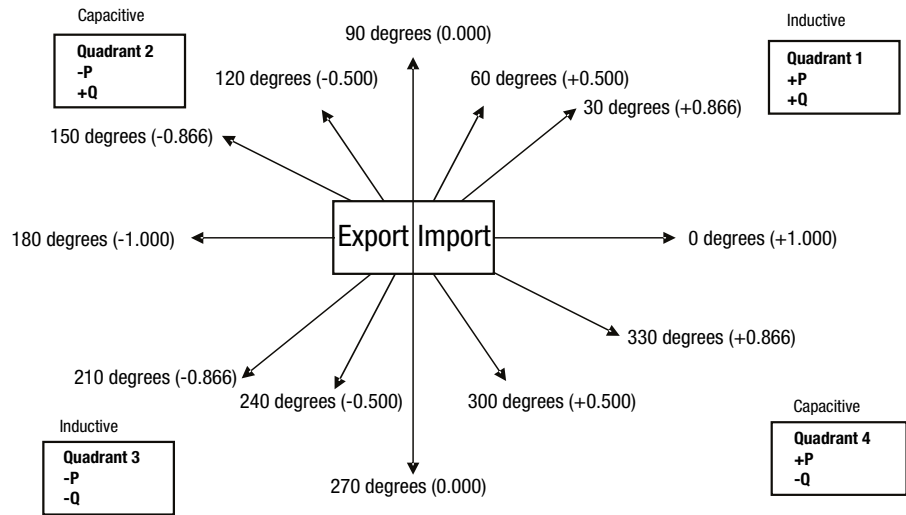

Connections	Quadrant	Sign of Active Power (P)	Sign of Reactive Power (Q)	Sign of Power Factor (PF)	Inductive/ Capacitive
Import	1	+ P	+ Q	+	L
Import	4	+ P	- Q	+	C
Export	2	- P	+ Q	-	C
Export	3	- P	- Q	-	L

Inductive means Current lags Voltage

Capacitive means Current leads Voltage

When the instrument displays Active power (P) with “ + ” (positive sign) , the connection is “ **Import** ” .

When the instrument displays Active power (P) with “ - ” (negative sign) , the connection is “ **Export** ” .

9. Programming via the RS485 (Modbus) interface

Follow the subsequent steps to program the transducer via the RS485 interface and Modbus:

Step 1: Connection

Connect the Modbus cable according to the connection diagram in Chapter 5.5. Please observe also the information in the Modbus (RS485) interface definition in Chapter 13.

Step 2: Programming

Program SIRAX BT5700 via the Modbus RTU interface and the CB-Configurator software. Please observe the detailed Modbus description in Chapter 13.

Connect the power supply to SIRAX BT5700 before programming.

10. Service, maintenance and disposal



For devices that have not been opened in the factory, no warranty or guarantee can be assumed.

10.1 Repair work and modifications

Repair work and modifications shall exclusively be carried out by the manufacturer. Do not open the housing of the device. In case of any tampering with the device, the warranty claim shall lapse. We reserve the right of changing the product to improve it.

10.2 Calibration and new adjustment

Each device is adjusted and checked before delivery. The condition as supplied to the customer is measured and stored in electronic form.

The uncertainty of measurement devices may be altered during normal operation if, for example, the specified ambient conditions are not met.

10.3 Cleaning

The display and the operating keys should be cleaned in regular intervals. Use a dry or slightly moist cloth for this.



Damage due to detergents

Detergents may not only affect the clearness of the display but also can damage the device. Therefore, do not use detergents.

10.4 Disposal



The disposal of devices and components may only be realised in accordance with good professional practice observing the country-specific regulations. Incorrect disposal can cause environmental risks.

10.5 Return

All devices delivered to Camille Bauer Metrawatt AG shall be free of any hazardous contaminants (acids, lyes, solutions, etc.). Use original packaging or suitable transport packaging to return the device.



Damage by returning

Damages caused by improper returning, no warranties or guarantees can be given.

11. Technical data

System

Connection types: Three wire, three phase system, unbalanced load
Four wire, three phase system, unbalanced load

Inputs

Nominal current: 1 A / 5 A
Maximum continuous input current: 120% of Rated value
Nominal input current burden: 0,6 VA per Phase
Max short duration current input: 20 x Rated Value (1s application repeated 5 times at 5 min. intervals)
System CT Primary values: Std. Values 1 to 9999 A (1 or 5 A secondaries)

Nominal voltage: 440 V_{LL}
Max continuous input voltage: 120% of Rated Value
Max short duration input voltage: 2 x Rated Value (1S application repeated 10 times at 10s intervals)
Nominal input voltage burden: 0.2VA approx. per phase
System PT primary value: 100 V_{LL} to 692.8 KV_{LL}

Auxiliary Supply 12 ... 48V DC \pm 10% (Article-Nr. 175 275)
100 ... 250V AC/DC \pm 10% (Article-Nr. 175 134)
Auxiliary supply burden: <4VA approx.

Operating Measuring Ranges

Voltage: 5 ... 120% of Rated Value
Current: 5 ... 120% of Rated Value
Frequency: 40 ... 70 Hz
Power factor: 0.6 Lag ... 1 ... 0.6 Lead

Accuracy

Voltage: \pm 0,5% of range
Current: \pm 0,5% of range
Frequency: \pm 0,15% of mid frequency
Active power: \pm 0,5% of range
Re-active power: \pm 0,5% of range
Apparent Power: \pm 0,5% of range
Active energy: \pm 0,5% of range
Re-active energy: \pm 0,5% of range
Apparent energy: \pm 0,5% of range
Power Factor: \pm 1 % of Unity
Angle: \pm 1 % of range (0 - 360)



Variation due to influence quantity is 100% of class index for all other parameters except energy.

Mechanical attributes

Orientation: Any
Bezel size: 96 mm x 96 mm
Panel cut out: 92+0.8 mm x 92+0.8 mm detail see cut out drawing
Overall depth: <80mm
Housing material: Lexan 940 (polycarbonate),
V-0 acc. to UL94, self-extinguishing,
non-dripping, free of halogen

Weight:	ca. 460 g
Dimensions:	see dimensional drawings
Display:	2 Line Display with backlight, update rate approx. 1 sec.
User interface:	2 push buttons
Terminals:	Screw-type terminals

Reference conditions for Accuracy

Reference:	23 °C ± 2 °C
temperature Input frequency:	50 or 60Hz ± 2%
Input waveform:	Sinusoidal (distortion factor 0.005)
Input Voltage:	Rated value
Auxiliary supply voltage:	Rated Value ± 1 %
Auxiliary supply frequency:	Rated Value ± 1 %
Power Factor:	0.8 Lag...1...0.8 Lead

Nominal range of use of influence quantities for measurands

Voltage:	5 ... 120 % of Rated Value
Current:	5 ... 120 % of Rated Value
Input frequency:	Rated Value ± 10 %
Temperature:	0 to 50 °C
Auxiliary supply voltage:	Rated Value ± 10 %
Auxiliary supply frequency:	Rated Value ± 10 %
Temperature Coefficient:	0.025% / °C for Voltage (50 ... 120% of Rated Value)
(For Rated value range of use 0... 50 °C)	0.05% / °C for Current (10 ... 120% of Rated Value)
Error change due to variation of an influence quantity:	2 * Error allowed for the reference condition applied in the test

Standards

Terms, definitions and test methods:	EN60688
EMC Immunity:	EN61326
	10V/m min-Level 3 industrial low level electromagnetic radiation environment EN61000-4-3
Safety:	EN61010-1 : 2010, EN61010-2 : 030
IP for water & dust:	EN60529

Isolation

Dielectric voltage withstand test	2.2 kV RMS 50 Hz for 1 minute between all electrical circuits
-----------------------------------	---

Environmental

Operating temperature:	- 5 to 60 °C
Storage temperature:	- 20 to +65 °C
Relative humidity:	0 ... 90 %
Warm UP time:	min. 3 minute
Shock :	15g in 3 planes
Vibration:	10 ... 55 Hz, 0.15mm amplitude

Outputs

Modbus (RS485)	via plug-in terminal (A, B, G)
Protocol:	Modbus (RS485)
Baud rate:	2'400, 4'800, 9'600, 19'200 Baud (programmable)
Parity:	Odd or even, with 1 Stop Bit, or None with 1 or 2 Stop Bits

11. Dimensional drawings

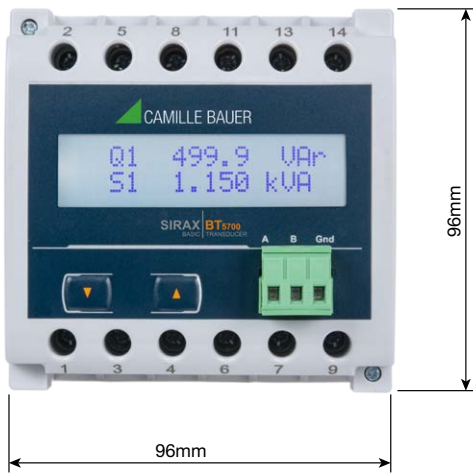

13. Interface Definition Modbus RTU

SIRAX BT5700 supports Modbus RTU protocol (RS485).

The permissible address range for the BT5700 is between 1 and 247. Broadcast Mode (address 0) is not allowed.

The maximum latency time of an BT5700 is 200ms i.e. this is the amount of time that can pass before the first response character is output.

After sending any query through software (of the Master), it must allow 200ms of time to elapse before assuming that the BT5700 is not going to respond. If slave does not respond within 200 ms, Master can ignore the previous query and can issue fresh query to the slave.

13.1 Modbus functions

Following code functions are provide:

Function code	Function	Address
03	Read holding registers	40001 to 40081
04	Read input registers	30001 to 30231
16	Presets multiple registers	40001 to 40081

Example of read out measurement

Query:

Device address	Function code	Start address	Nr. of register	CRC
0x05	0x04	0x000C	0x0006	0xB18F

Response:

Device address	Function code	Nr. of databytes	Databytes	Databytes	Databytes	CRC
0x05	0x04	0x0C	0x3F8A5AA7	0x3F844A12	0x3F85DAD2	0x4759

Example of set slave address 5 to 2

Query:

Device address	Function code	Start address	Nr. of register	Nr. of bytes	Databytes 0...3	CRC
0x01	0x10	0x0014	0x0002	0x04	0x41700000	0xF387

Response:

Device address	Function code	Start address	Nr. of register	CRC
0x05	0x10	0x0014	0x0002	0x0048

Exception Cases: An exception code will be generated when BT5700 receives ModBus query with valid parity and error check but which contains some other error (e.g. Attempt to set floating point variable to an invalid value). The response generated will be "Function code" + 0x80.

01	Illegal function	The function code is not supported.
02	Illegal data address	Attempt to access an invalid address or an attempt to read or write part of a floating point value.
03	Illegal data value	Attempt to set a floating point variable to an invalid value.

13.2 Data types

All information are displayed as 32-bit float. There is no representation for floating point numbers in the Modbus specification.

The IEEE 754 standard as the most often used standard for the representation of floating numbers is applied.

- The first register contains the bits 16 – 31
- The second register contains the bits 0 – 15

32-Bit Float (Real32)

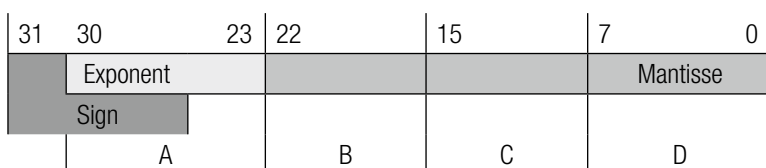

0x4017																0x4C05																										
0	1	0	0	0	0	0	0	0	0	0	0	0	0	0	0	0	0	1	0	1	0	1	1	1	1	0	1	0	0	1	1	0	0	0	0	0	0	0	0	1	0	1
+ Exponent: 128-127=1																Mantisse=1.010000000010111010011000000101=1.18200743198394781526789																										

Measuring value P = 1.18200743198394781526789 * 2¹ = 2.3640149 W

TABLE 1: 3 X Registeradress (measured Parameter)

Adress (Register)	Name	Description	3P 4W	3P 3W
30001	U1N	Voltage phase L1 to N	• (L1-N)	• (L1-L2)
30003	U2N	Voltage phase L2 to N	• (L2-N)	• (L2-L3)
30005	U3N	Voltage phase L3 to N	• (L3-N)	• (L3-L1)
30007	I1	Current in phase L1	•	•
30009	I2	Current in phase L2	•	•
30011	I3	Current in phase L3	•	•
30013	P1	Active power phase 1 (L1 – N)	•	–
30015	P2	Active power phase 2 (L2 – N)	•	–
30017	P3	Active power phase 3 (L3 – N)	•	–
30019	S1	Apparent power phase 1 (L1 – N)	•	–
30021	S2	Apparent power phase 2 (L2 – N)	•	–
30023	S3	Apparent power phase 3 (L3 – N)	•	–
30025	Q1	Reactive power phase 1 (L1 – N)	•	–
30027	Q2	Reactive power phase 2 (L2 – N)	•	–
30029	Q3	Reactive power phase 3 (L3 – N)	•	–
30031	PF1	Power factor phase 1 (L1 – N)	•	–
30033	PF2	Power factor phase 2 (L2 – N)	•	–
30035	PF3	Power factor phase 3 (L3 – N)	•	–
30037	Phi 1	Phase angle 1	•	–
30039	Phi 2	Phase angle 2	•	–
30041	Phi 3	Phase angle 3	•	–
30043	$\emptyset U$	Average value of voltages	•	•
30045	$\sum U$	Sum of voltages	•	•
30047	$\emptyset I$	Average value of current	•	•
30049	$\sum I$	Sum of current	•	•
30051	P	Average value of active power	•	•
30053	$\sum P$	Sum of active power	•	•
30055	$\emptyset S$	Average value of apparent power	•	•
30057	$\sum S$	Sum of apparent power	•	•
30059	$\emptyset Q$	Average value of reactive power	•	•
30061	$\sum Q$	Sum of reactive power	•	•
30063	$\emptyset PF$	Average value of power factor	•	•
30065	$\sum PF$	Sum of power factor	•	–
30067	$\emptyset \Phi$	Average value of phase angle	•	•
30069	$\sum \Phi$	Sum of phase angle	•	–
30071	F	System frequency	•	•
30073	$\int P_{inc}$	Active power incoming	•	•
30075	$\int P_{out}$	Active power outgoing	•	•
30077	$\int Q_{inc}$	Reactive Power incoming	•	•
30079	$\int Q_{out}$	Reactive Power outgoing	•	•
30081	$\int S$	Apparent power	•	•

Adress (Register)	Name	Description	3P 4W	3P 3W
30133	ØU max.	Maximum of the voltage average value	•	•
30135	ØU min.	Minimum of the voltage average value	•	•
30141	ØI max.	Maximum of the current average value	•	•
30143	ØI min.	Minimum of the current average value	•	•
30145	∫P_inc *	Active power incoming (kWh)	•	•
30147	∫P_out *	Active power outgoing (kWh)	•	•
30149	∫Q_inc *	Reactive Power incoming (kvarh)	•	•
30151	∫Q_out *	Reactive Power outgoing (kvarh)	•	•
30153	∫S *	Apparent power (kvah)	•	•
30201	U12	Voltage phase L1 to L2	•	–
30203	U23	Voltage phase L2 to L3	•	–
30205	U31	Voltage phase L2 to L1	•	–
30225	IN_calc	Neutral current (calculated)	•	–
30513	Variable 1	Quantity is defined by user (see 40513 ... 40534)		
30515	Variable 2	Quantity is defined by user (see 40513 ... 40534)		
30517	Variable 3	Quantity is defined by user (see 40513 ... 40534)		
30519	Variable 4	Quantity is defined by user (see 40513 ... 40534)		
30521	Variable 5	Quantity is defined by user (see 40513 ... 40534)		
30523	Variable 6	Quantity is defined by user (see 40513 ... 40534)		
30525	Variable 7	Quantity is defined by user (see 40513 ... 40534)		
30527	Variable 8	Quantity is defined by user (see 40513 ... 40534)		
30529	Variable 9	Quantity is defined by user (see 40513 ... 40534)		
30531	Variable 10	Quantity is defined by user (see 40513 ... 40534)		
30533	Variable 11	Quantity is defined by user (see 40513 ... 40534)		
30535	Variable 12	Quantity is defined by user (see 40513 ... 40534)		
30537	Variable 13	Quantity is defined by user (see 40513 ... 40534)		
30539	Variable 14	Quantity is defined by user (see 40513 ... 40534)		
30541	Variable 15	Quantity is defined by user (see 40513 ... 40534)		
30543	Variable 16	Quantity is defined by user (see 40513 ... 40534)		
30545	Variable 17	Quantity is defined by user (see 40513 ... 40534)		
30547	Variable 18	Quantity is defined by user (see 40513 ... 40534)		
30549	Variable 19	Quantity is defined by user (see 40513 ... 40534)		
30551	Variable 20	Quantity is defined by user (see 40513 ... 40534)		

* see Register 40081 (Page 30, Table 2)

TABLE 2: Description of 4X-Registers:

Address	Name	Read/Write	Description																																																																								
40005	Energy unit	R/W	This address is used to set energy unit in Wh, kWh & MWh. Write one of the following value to this address. 1: Energy in Wh. 2: Energy in kWh. 3: Energy in MWh.																																																																								
40007	System Voltage	R	This address is read only and displays System Voltage																																																																								
40009	System Current	R	This address is read only and displays System Current																																																																								
40011	System Type	R/W	This address is used to set the System type. Write one of the following value to this address. 2: 3 Phase 3 Wire 3: 3 Phase 4 Wire. Writing any other value will return error.																																																																								
40015	Reset Energy Counter	W	This address is used to reset the Energy Counter. Write zero value to this register to reset the energy counter. Writing any other value will return an error.																																																																								
40019	Rs485 Set-up Code	R/W	This address is used to set the baud rate, Parity, Number of stop bits.																																																																								
			<table border="1"> <thead> <tr> <th>Value</th> <th>Baud rate</th> <th>Parity</th> <th>Stop bit</th> <th>Value</th> <th>Baud rate</th> <th>Parity</th> <th>Stop bit</th> </tr> </thead> <tbody> <tr> <td>0</td> <td>2400</td> <td>NONE</td> <td>1</td> <td>8</td> <td>9600</td> <td>NONE</td> <td>1</td> </tr> <tr> <td>1</td> <td>2400</td> <td>NONE</td> <td>2</td> <td>9</td> <td>9600</td> <td>NONE</td> <td>2</td> </tr> <tr> <td>2</td> <td>2400</td> <td>EVEN</td> <td>1</td> <td>10</td> <td>9600</td> <td>EVEN</td> <td>1</td> </tr> <tr> <td>3</td> <td>2400</td> <td>ODD</td> <td>1</td> <td>11</td> <td>9600</td> <td>ODD</td> <td>1</td> </tr> <tr> <td>4</td> <td>4800</td> <td>NONE</td> <td>1</td> <td>12</td> <td>19200</td> <td>NONE</td> <td>1</td> </tr> <tr> <td>5</td> <td>4800</td> <td>NONE</td> <td>2</td> <td>13</td> <td>19200</td> <td>NONE</td> <td>2</td> </tr> <tr> <td>6</td> <td>4800</td> <td>EVEN</td> <td>1</td> <td>14</td> <td>19200</td> <td>EVEN</td> <td>1</td> </tr> <tr> <td>7</td> <td>4800</td> <td>ODD</td> <td>1</td> <td>15</td> <td>19200</td> <td>ODD</td> <td>1</td> </tr> </tbody> </table>	Value	Baud rate	Parity	Stop bit	Value	Baud rate	Parity	Stop bit	0	2400	NONE	1	8	9600	NONE	1	1	2400	NONE	2	9	9600	NONE	2	2	2400	EVEN	1	10	9600	EVEN	1	3	2400	ODD	1	11	9600	ODD	1	4	4800	NONE	1	12	19200	NONE	1	5	4800	NONE	2	13	19200	NONE	2	6	4800	EVEN	1	14	19200	EVEN	1	7	4800	ODD	1	15	19200	ODD	1
			Value	Baud rate	Parity	Stop bit	Value	Baud rate	Parity	Stop bit																																																																	
			0	2400	NONE	1	8	9600	NONE	1																																																																	
			1	2400	NONE	2	9	9600	NONE	2																																																																	
			2	2400	EVEN	1	10	9600	EVEN	1																																																																	
			3	2400	ODD	1	11	9600	ODD	1																																																																	
			4	4800	NONE	1	12	19200	NONE	1																																																																	
			5	4800	NONE	2	13	19200	NONE	2																																																																	
6	4800	EVEN	1	14	19200	EVEN	1																																																																				
7	4800	ODD	1	15	19200	ODD	1																																																																				
40021	Node Address	R/W	This register address is used to set Device address between 1 to 247 .																																																																								
40025	Min - Reset	W	This address is used to reset the Min parameters value. Write Zero value to this register to reset the Min parameters. Writing any other value will return an error.																																																																								
40027	Max - Reset	W	This address is used to reset the Max parameters value. Write Zero value to this register to reset the Max parameters. Writing any other value will return an error.																																																																								
40033	PT Primary	R/W	This address allows the user to set PT Primary value. The maximum settable value is 692.8kV & also depends on the per phase 666 MVA Restriction of power combined with CT primary.																																																																								
40035	CT Primary	R/W	This address allows the user to set CT Primary value. The maximum settable value is 9999 & also depends on the per phase 666 MVA Restriction of power combined with PT primary.																																																																								
40037	Sys Power	W	System Power (Read Only) is the Nominal system power based on the values of Nominal system volts and Nominal system current.																																																																								
40039	Energy Digit Reset Count	R/W	This address is used to set the rollover count for energy. If Energy on Modbus is in Wh, rollover count can be from 7 to 14. If it is in kWh then rollover count can be from 7 to 12 & for MWh rollover count can be from 7 to 9.																																																																								
40041	Word Order	R/W	Word Order controls the order in which SIRAX BT5700 receives or sends floating - point numbers:- normal or reversed register order. In normal mode, the two registers that make UP a floating point numbers are sent most significant bytes first. In reversed register mode, the two registers that make UP a floating point numbers are sent least significant bytes first. To set the mode, write the value '2141.0' into this register-the instrument will detect the order used to send this value and set that order for all ModBus transaction involving floating point numbers.																																																																								

40043	CT secondary	R/W	This address is used to read and write the CT secondary value. Write one of the following values to this address. 1: 1A CT secondary 5: 5A CT secondary writing any other value will return an error.																				
40071	Passwort	R/W	This address is used to set & reset the password. Valid Range of Password can be set is 0000 - 9999. 1) If password lock is present & if this location is read it will return zero. 2) If Password lock is absent & if this location is read it will return One. 3) If password lock is present & to disable this lock first send valid pas word to this location then write "0000" to this location 4) If password lock is present & to modify 4X parameter first send valid password to this location so that 4X parameter will be accessible for modification. 5) If for in any of the above case invalid password is send then meter will return exceptional error 2.																				
40077	Auto-Scroll	R/W	This address is used to activate or de-activate the auto scrolling. Write 0: Deactivate 1: Activate, Writing any other value will return an error.																				
40079	30mA start current	R/W	This address is used to activate or de-activate the 30 mA start current elimination write 0: Deactivate 30 (Decimal): Activate Writing any other value will return an error.																				
40081	Aktualisierungsrate	R/W	Update rate of the energy meter in the process image (30145 ... 30153)																				
40513	Variable 1	R/W	defines the value of the register 30513/30514																				
40514	Variable 2	R/W	defines the value of the register 30515/30516																				
40515	Variable 3	R/W	<table border="1"> <thead> <tr> <th>Value</th> <th>Name</th> </tr> </thead> <tbody> <tr> <td>0</td> <td>Voltage UL1</td> </tr> <tr> <td>2</td> <td>Voltage UL2</td> </tr> <tr> <td>4</td> <td>Voltage UL3</td> </tr> <tr> <td>...</td> <td></td> </tr> <tr> <td>70</td> <td>Frequenz</td> </tr> <tr> <td>...</td> <td></td> </tr> <tr> <td>144</td> <td>Active power incoming</td> </tr> <tr> <td>224</td> <td>Neutral current</td> </tr> <tr> <td>Wert</td> <td>= 3X Register Adress – 30001</td> </tr> </tbody> </table>	Value	Name	0	Voltage UL1	2	Voltage UL2	4	Voltage UL3	...		70	Frequenz	...		144	Active power incoming	224	Neutral current	Wert	= 3X Register Adress – 30001
Value	Name																						
0	Voltage UL1																						
2	Voltage UL2																						
4	Voltage UL3																						
...																							
70	Frequenz																						
...																							
144	Active power incoming																						
224	Neutral current																						
Wert	= 3X Register Adress – 30001																						
40516	Variable 4	R/W																					
40517	Variable 5	R/W																					
40518	Variable 6	R/W																					
40519	Variable 7	R/W																					
40520	Variable 8	R/W																					
50521	Variable 9	R/W																					
40522	Variable 10	R/W																					
40523	Variable 11	R/W																					
40524	Variable 12	R/W																					
40527	Variable 13	R/W																					
40528	Variable 14	R/W																					
40529	Variable 15	R/W																					
40530	Variable 16	R/W																					
40531	Variable 17	R/W																					
40532	Variable 18	R/W																					
40533	Variable 19	R/W																					
40534	Variable 20	R/W	defines the value of the register 30551/30552																				