

UNIVERSAL MEASURING UNIT FOR HEAVY CUR- RENT VARIABLES

CONTROLLING
ANALYZING
METERING

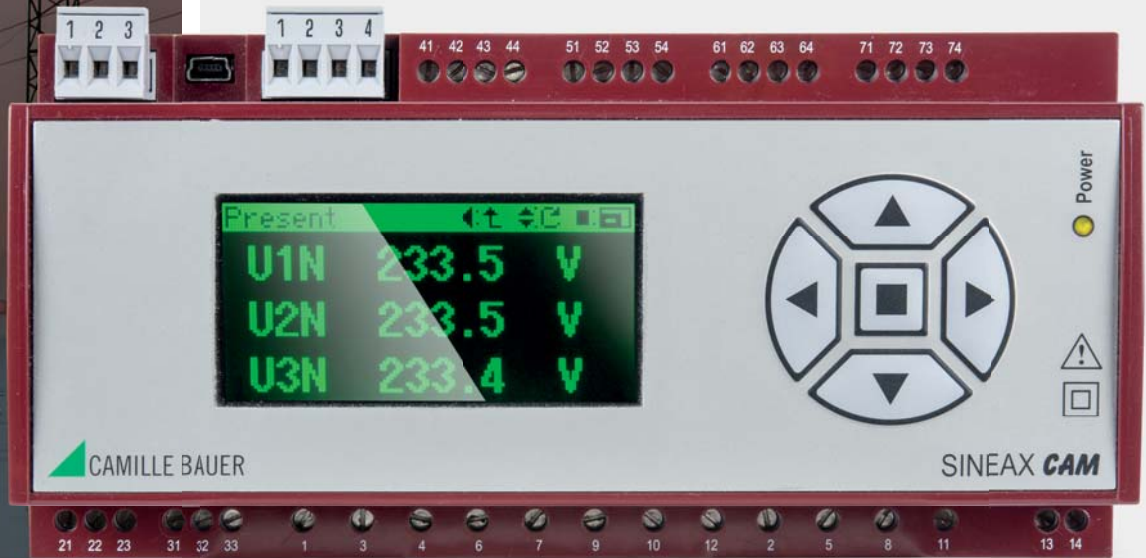

SINEAX CAM



THE UNCOMPROMISING MEASUREMENT SOLUTION

The universal measurement system of the CAM is designed for a high-precision and disturbance insensitive measurement in multi-phase heavy current systems. The consistent (uninterrupted) measurement records reliably each change in the monitored mains. With its unique

combination of hardware and software modules this measuring device provides a solution for each measurement task. The adaption to this task is performed quick and easy by means of the CB-Manager software.

- Single phase, 2-, 3- and 4-wire systems
- Strongly distorted networks in industrial environment
- For zero crossing resp. multi-cycle controls
- For phase angle controls
- Measurement after frequency converters
- Right and left turning systems
- 4 quadrant operation

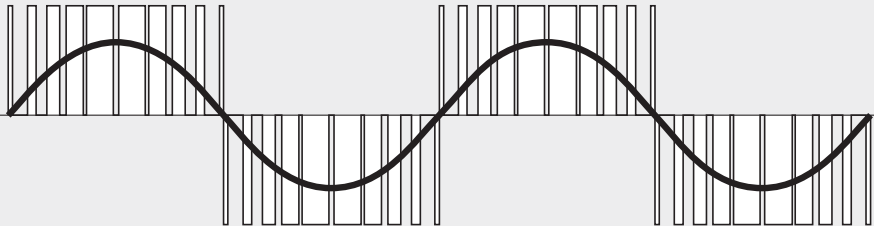

Typical frequency converter signal

MEASUREMENT ADAPTABLE TO APPLICATION

The speed CAM is working with resp. is relaying measured data to the corresponding outputs, can be configured almost freely. But it has to be adapted to the specific application. Broadly spoken: The more the signal differs from the ideal sine wave, the longer the averaging interval of the measurement should be selected.

RESPONSE TIMES (AT 50 HZ, 1 CYCLE AVERAGING)	MIN.*	MAX.*
Measured data at Modbus-/USB interface	37 ms	57 ms
Analogue outputs	47 ms	67 ms
Digital outputs (via logic module)	45 ms	65 ms
Relay outputs (via logic module)	67 ms	87 ms

* Response time to changes of the input.
But: Refreshing of the values after each system cycle.

The accuracy (IEC/EN 60 688), the device can achieve under reference conditions, amounts to:

MEASURED QUANTITY	BASIC UNCERTAINTY	MEASURED QUANTITY	BASIC UNCERTAINTY
Voltage, current	± 0.1 %	Power factor	± 0.1°
Power, imbalance	± 0.2 %	Energy	± 0.2% (full scale)
Harmonics, THD, TDD	± 0.5 %	Active energy (direct connection)	Class 1 (EN 62053-21)
Frequency	± 0.01 Hz	Reactive energy	Class 2 (EN 62053-23)

CONTROLLING - ANALYZING - METERING

The evaluation and analysis functions of the CAM provide a huge number of measured quantities, which may be grouped as follows:

- Instantaneous values: An image of the present system state. External quantities (like temperatures or circuit states) can be acquired via the I/O interface. The logic module provides comprehensive analysis and alarming facilities for these data.
- System analysis: To determine the additional burden for operating resources due to harmonics (originating from non-linear loads) or heating effects which occur due to unbalanced system load.
- Energy consumption: Active and reactive energy as well as mean-values with trend are provided. Using the data logger also the variance of the load in the course of time may be recorded, perhaps in terms of load profiles or as extreme values within a billing interval.
- Recording with time: Alarms, events, operator actions, extreme values (minimum + maximum).

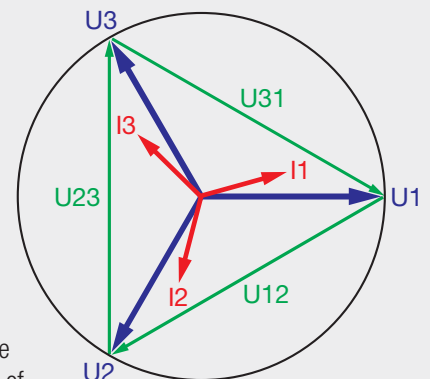



FREE COMPOSITION OF THE REQUIRED FUNCTIONS

CAM BASIC DEVICE AS INITIAL POSITION

- Measurement system: 3 voltages and 4 currents
- Modbus/RTU- and USB interface for service, configuration and measurement acquisition
- 2 relay outputs
- Logic module for monitoring/control
- Security system for granting access rights for up to 3 users
- Synchronizable real-time clock as time base
- Operating hours counter

CUSTOMER SPECIFIC ADAPTION WITH OPTIONS

- I/O interface: analog and digital I/Os
- Data logger for measurement recordings for longer time periods
- Lists: Recording of alarms, events and system messages
- Graphic display: for measurement display and alarm handling
- Modbus/TCP communication via Ethernet
- IEC 61850 communication via Ethernet

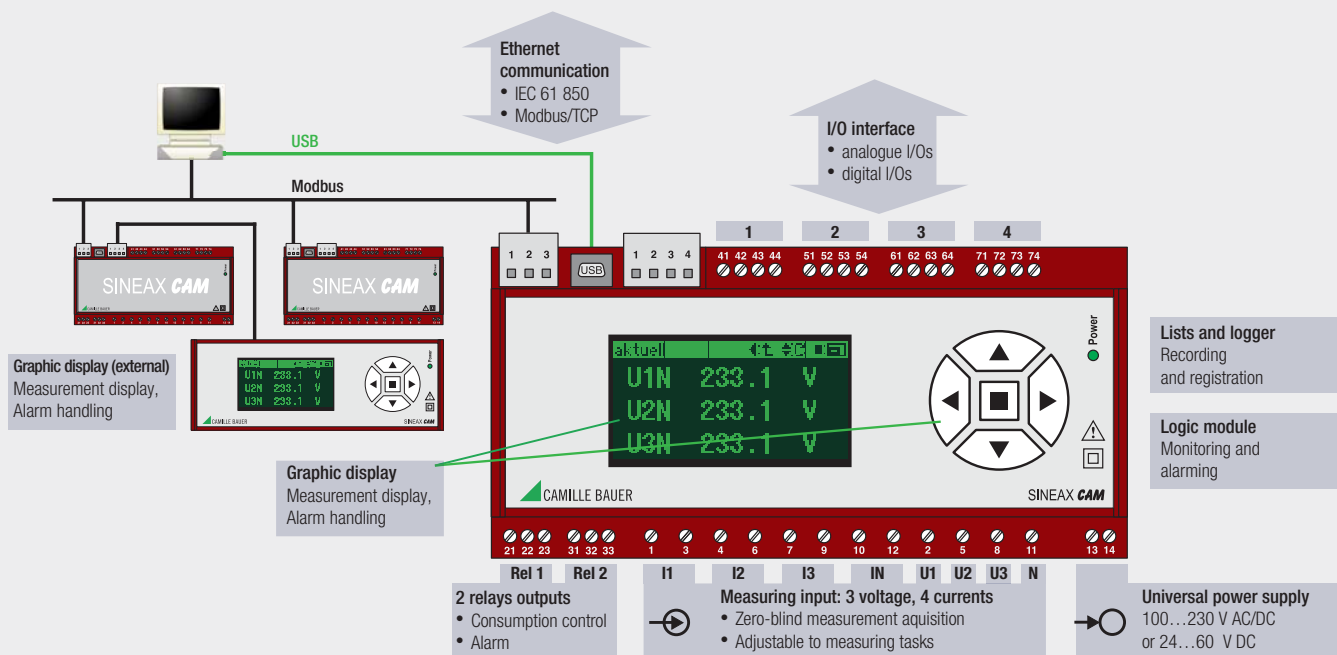

ADAPTED FREQUENCY RANGE

The more exact the fundamental frequency can be measured the more stable and more precise are the measurement results. Superimposed lower frequency components (as flicker), harmonics and ripple control signals can make the determination quite difficult. The best possible results can be achieved by using narrow-edged bandpass filters to filter out disturbing components. To do so the frequency range of the application must be restricted. Three different ranges are available:

- 45...50/60...65 Hz
Application in the energy supply of distribution networks or in industrial plants. Rated frequencies of 50 and 60 Hz are covered, with the possible variations which may occur during steady operation.

- 10...50/60...70 Hz

Using this version also the dynamic behaviour of aggregates can be monitored, which are used for distributed energy supplies, e.g. on ships. Due to its high dynamic this version is predestined for the application in test stands, to monitor e.g. the behaviour during start-up or load changes. Another application field is the measurement behind frequency converters.

- 10...50/60...140 Hz

This version covers the full application range of frequency converters, as they are used nowadays for different purposes in drive engineering.

ROGOWSKI VERSION

Current measurement: Voltage inputs with rated value 5 V AC, measurement up to max. 10 V AC





PARAMETRIZATION, SERVICE AND MONITORING

The CB-Manager software provides to the user the following functions:

- Complete parametrization of the CAM (also offline)
- Acquisition and recording of measured quantities
- Archiving of configuration and measurement files
- Setting or resetting of meter contents
- Selective reset of extreme values
- Setting of interface parameters
- Adjustment of analog inputs
- Simulation of all I/O module functions
- Comprehensive help system

A security system can be activated to restrict the access to the device. This way e.g. the simulation or setting of limit values may be granted for selected users only.

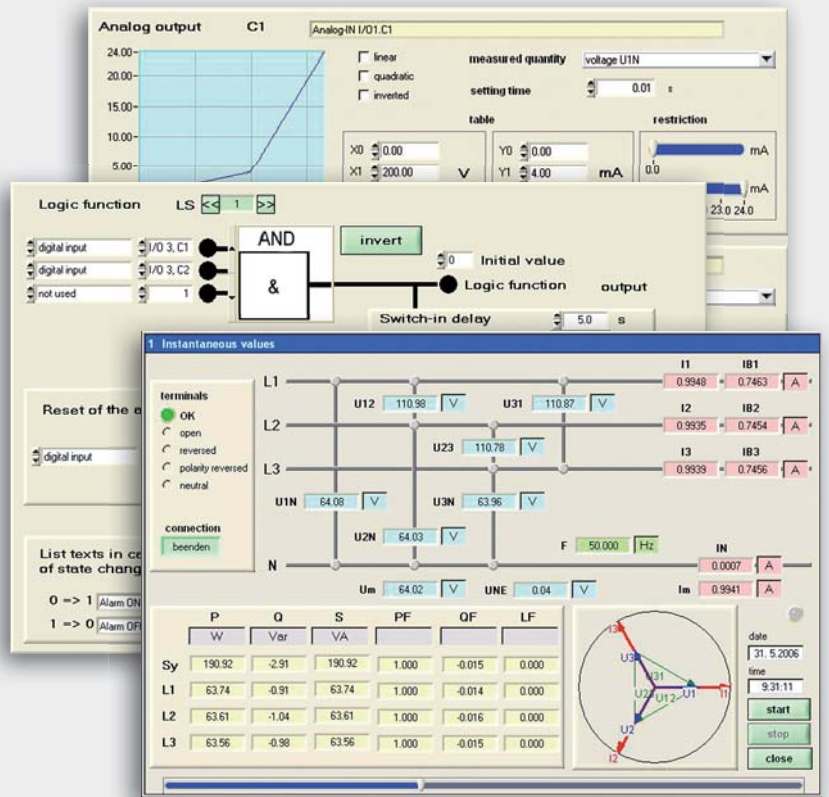

MONITORING AND ALARMING USING THE LOGIC MODULE

The logic module is a unique system, which allows to combine any logic state and to derive desired actions. It consists of up to 32 logic functions with 3 inputs each. Here an overview of the possibilities:

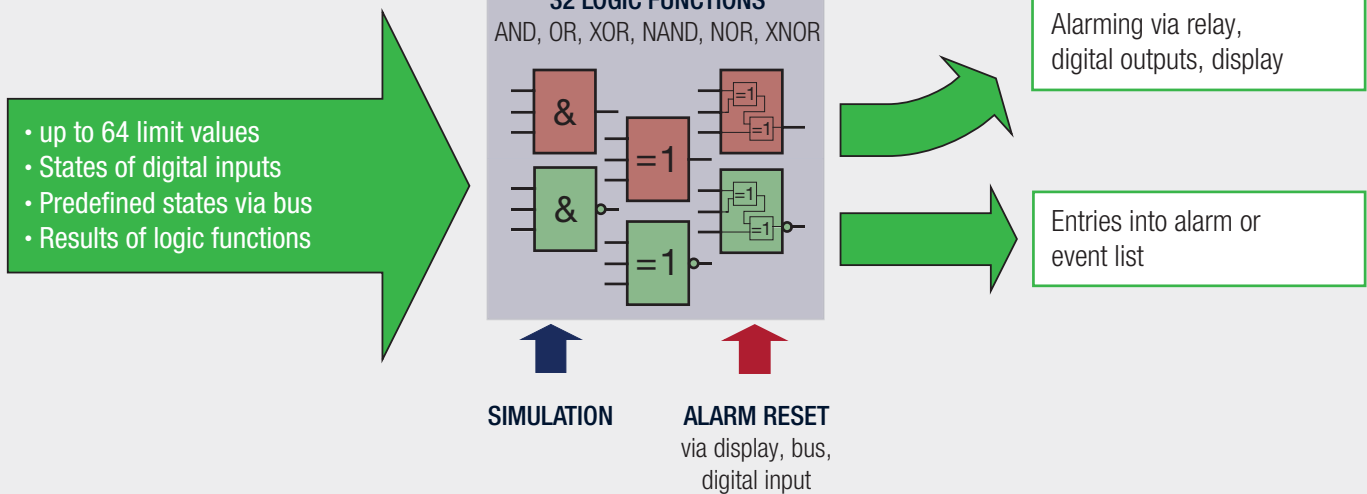

POSSIBLE APPLICATIONS

- Limit monitoring of a single quantity (e.g. overcurrent) or any combinations (e.g. phase failure), also applicable on external quantities via I/O interface.
- Monitoring of external devices: Self monitoring signals, circuit states etc.
- Changeovers of operating modes like local/remote (day/night) or normal/test
- Peak load optimization
- Recording: Alarms, events, acknowledgments, switching of consumers ON/OFF etc.
- Complex measurement analysis including external measurement data and state information
- Remote control: digital and relay outputs may be used for alarming or control functions via bus interface, independent of the normal device function.



I/O INTERFACE

POSSIBILITIES AND APPLICATIONS

I/O modules can be assembled according to individual needs. Up to 4 modules with selectable functionality may be used. Five different hardware modules are available.

ANALOGUE OUTPUTS

± 20 mA

2 outputs per module

0/4...20 mA

2 outputs per module

- On-site display via analog display units
- Heavy-current measurements for PLC

DIGITAL OUTPUTS

12/24 VDC

3 outputs per module (switchable to inputs)

- Alarming output of the logic module
- State reporting
- Pulse output (SO) to external counter
- Remote controllable

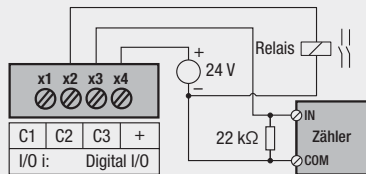

ANALOGUE INPUTS

0/4...20 mA

2 outputs per module

- Acquisition of ext. quantities, e.g. temperature
- Automatic metering of input quantity
- Scalable, e.g. 4...20 mA to 0...100 °C
- Scaled measurement displayable on graphic display and requestable via interface

DIGITAL INPUTS

12/24 VDC

3 inputs per module (switchable to outputs)

48/125 VDC

3 inputs per module (only in position 4)

- Acquisition of external state information
- Trigger or release signal for logic module
- Pulse input for metering

POSITION OF THE I/O MODULES

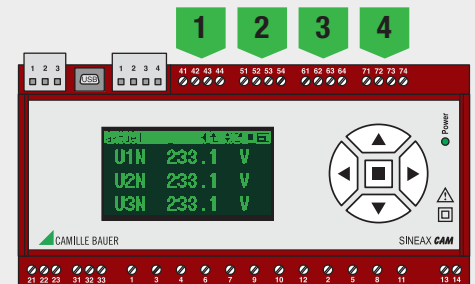

For safety reasons the selection of the modules must be done at time of ordering. Later modifications can be performed in our factory only.

ACCESSORIES

EX-FACTORY ROGOWSKI CURRENT SENSORS

DESCRIPTION	ARTICLE NO.
Single phase, ACP FLEX 3000_5, 2m, Ø194mm, measurement ranges 30/300/3000 A, 9 V supply via CAM	169 426
Three-phase, ACP FLEX 3003_5, 2m, Ø194mm, measurement ranges 30/300/3000 A, 9 V supply via CAM	169 434

The connection wires of these current sensors are equipped with end splices and therefore can be directly connected to the screw terminals of the CAM.

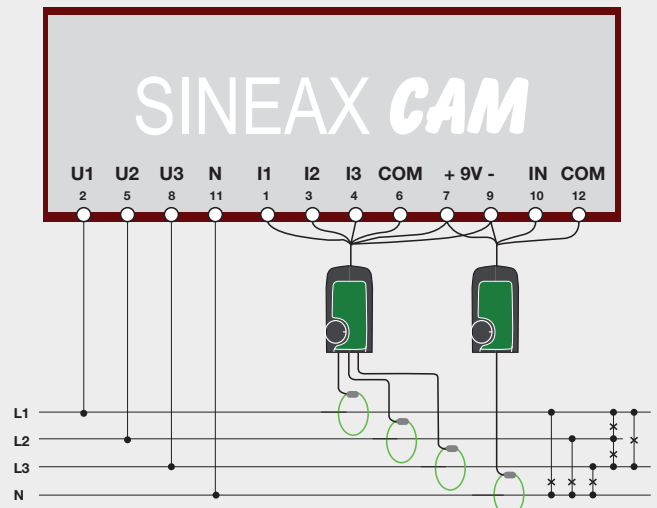

Example: ACP FLEX 300x_5 current sensors 30/300/3000 A, which need a 9 V power supply



LONG-TERM RECORDINGS AND LOGGING

The data logger allows to perform long-term recordings of measurement progressions or load profiles, e.g. to monitor the variable load of transformers, feeders or transmission lines. In addition to the recording of mean-values, fluctuations of instantaneous values may be registered to recognize load peaks at the earliest possible moment.

By means of the automatical meter reading a time synchronous reading of the meter contents of all devices may be performed, e.g. on a weekly, monthly or three months base. These values can be stored for any desired time, thus allow determining the energy consumption per time for billing purposes.

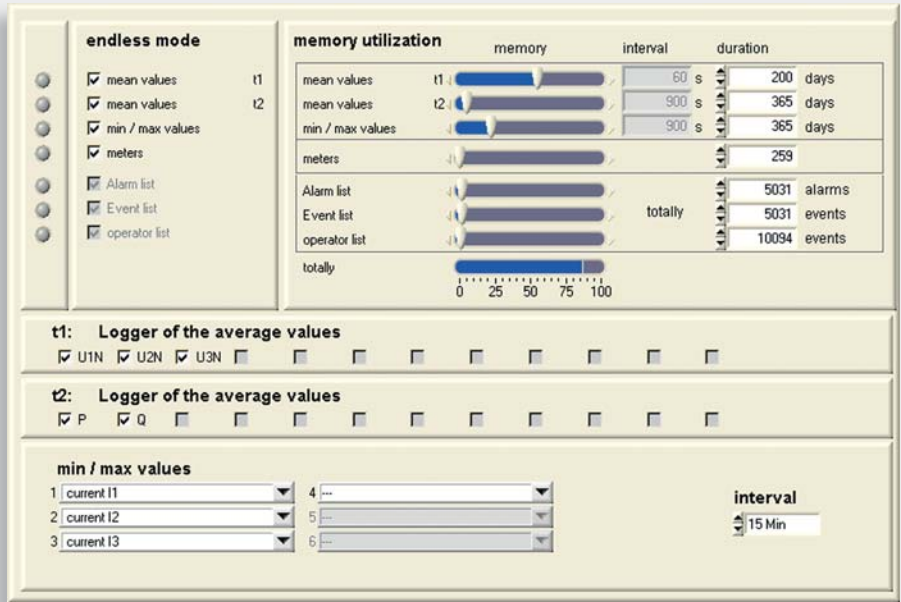

APPLICATION

- Recording of energy demands based on billing interval (load profiling)
- Acquisition of measurement fluctuations per billing interval
- Monitoring of feeders and transformers
- Gathering energy consumption by time synchronous meter readings
- Summary analysis using the CB-Analyzer software
- Recording of disturbances

LISTS: LOGGING OF ALARMS AND EVENTS

Lists allow a chronological recording of events, alarms and system messages. Each change of the system state and each access to the device can thus be reproduced and analyzed at a later time in a correct sequence. Each entry in the lists is time stamped.

Alarms and events can be defined in the logic module. A text can individually be assigned and is used for the list entry and for the display on the graphic display.

System events, such as power supply failure, changes of the device configuration or simulation of outputs, are predefined events. Their occurrence will be recorded automatically.

All lists are protected against manipulations. Therefore the user has no possibility to delete them directly. The provided memory can be freely allocated to lists and logger. A modification of the configuration, such as adding alarms, events or more mean-values, has no impact on the consistency of the logger. By no means previous logged data get lost.

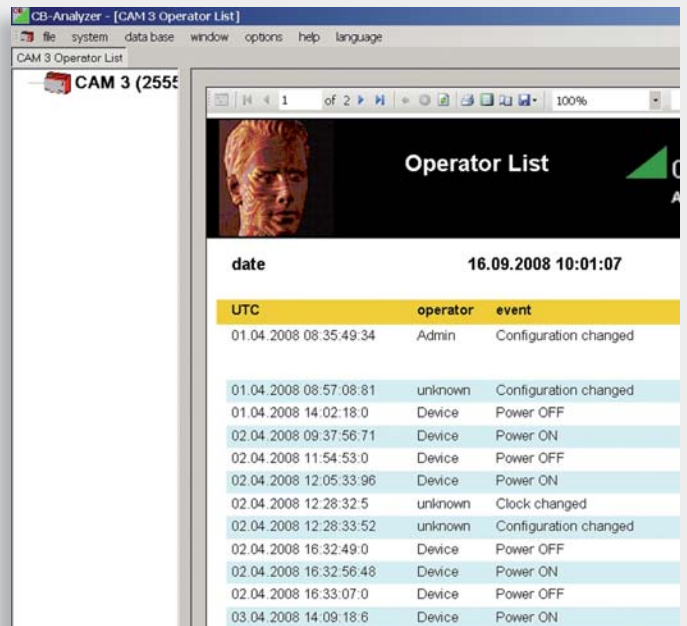

Operator list example in the CB-Analyzer software



VISUALIZATION, ALARM HANDLING AND DATA ANALYSIS

MEASUREMENT DISPLAY

The display is intended for the visualization of measured data and entries of the alarm, event or operator list. Also state information or measurement information of the I/O interface may be displayed. The user can customize the display almost freely to his individual needs. If necessary a preference display or an automatic sequence of different pages can be defined as well. The navigation is done using the easy to operate keypad.

ALARM HANDLING ON-SITE

Alarms can be configured to be displayed on-site and, if desired, to be acknowledgeable. This way a production may be monitored and controlled or an overload protection of operating resources may be realized. By means of the logic module the alarming can be redirected to a headquarter if no operators are on-site.

RESET FUNCTIONS

Via keypad meters and extreme values may be reset. The right to perform such operations can be restricted using the security system integrated in the device. If the system is activated, users must log-on first via display.

POSSIBLE SETTINGS

The user can modify display features, interface parameters and settings of the clock via keypad. This way the device may be adapted optimally to the environmental conditions on-site.

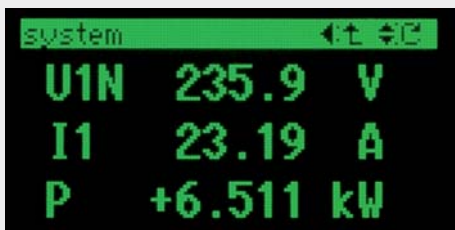

User specific display



Display of harmonics

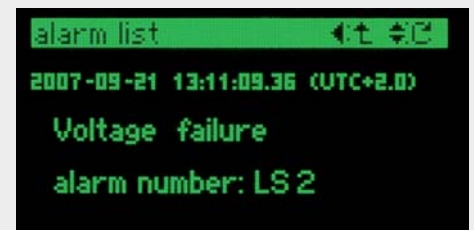

Alarm list entry

FAST COMMUNICATION VIA ETHERNET (MODBUS/TCP)

To be able to analyze the huge amount of measured data in real-time, a transmission medium with high bandwidth is necessary. Ethernet provides this high performance. CAM supports the protocols Modbus/TCP and NTP.

Modbus/TCP is a commonly used protocol for an easy access to configuration or measurement data. It is supported by a large number of visualization software tools and thus allows a fast implementation of the device. Via the Modbus/TCP interface all functions are supported, which are possible using the Modbus/RTU or USB interface.

So in addition to the measurement acquisition also the configuration of the device, as well as simulation, setting and resetting functions for measured data and I/Os are supported.

For the **time synchronization** of devices via Ethernet, NTP (Network Time Protocol) is the standard. Respective time servers are used in computer networks and are at free disposal via Internet as well. By means of NTP all devices can be used with a common time base.

APPLICATIONS

- Test stands for aggregates. Recording of the dynamic behaviour of motors and generators
- Remote monitoring and acquisition of power distribution systems via Intranet/Internet
- Recording of the dynamic loading of energy supply systems



CONTROL SYSTEM CONNECTION VIA IEC 61850 (ED. 1)

The communication standard IEC 61850 („Communication networks and systems in substations“) is the new standard for substation automation. Each possible device or system function is standardized and mapped in so called logical nodes (LN's). Also the complete communication and the engineering process are stated. So a high grade of independence from manufacturers is achieved. The field of application is situated in switchgears and transformer substations in the medium and high voltage area.

The group Metering and Measurement includes those nodes, which are specific for a measuring device like the CAM. As far as applicable also the node GGIO (Generic process I/O) is provided. Along with the measured data intended by the standard further values are attached in terms of private extensions.

MEASURED DATA

CAM provides the following logical nodes:

MMXU / MMXN: Instantaneous values of voltages, currents, frequency, powers and load factors as well as their maximum and minimum values. MMXU is used for asymmetrical 3 and 4 wire systems, MMXN for single phase and balanced load 3 and 4 wire systems.

MHAI / MHAN: Individual harmonics for voltages and currents, THD (total harmonic distortion) and TDD (total demand distortion) and their maximum values. MHAI is used for asymmetrical 3 and 4 wire systems, MHAN for single phase and balanced load 3 and 4 wire systems.

MMTR: Active and reactive energy meters for incoming and outgoing power. One instance for both high and low tariff.

MSTA: Mean values of voltage, current, active, reactive and apparent power as well as their maximum and minimum values on instantaneous values base. All measured within the same interval.

These values are provided for each phase as well.

MSQI: Imbalance of voltages and currents, calculated in accordance with two different methods.

GGIO: Maps the information of assembled analog and digital input modules. For each input an instance of GGIO processes state information, a measured quantity or metering pulses from an external device.



APPLICATION FIELD

The CAM with IEC 61850 support is a measuring device which bases on the use of conventional current and voltage transformers. Therefore it is most suitable for the modernization of substations, not touching the already installed conventional transformers.

GATEWAY FUNCTIONALITY

CAM not only provides measured data of the monitored system. It may be used as an IEC 61850 gateway as well. By means of GGIO instances state information (e.g. ON/OFF or a self-monitoring signal), analog measurements (e.g. a temperature) or metering pulses (kWh/kVArh) of non IEC 61850 capable external devices can be handled. These measurement data then can be accessed via the IEC 61850 interface.

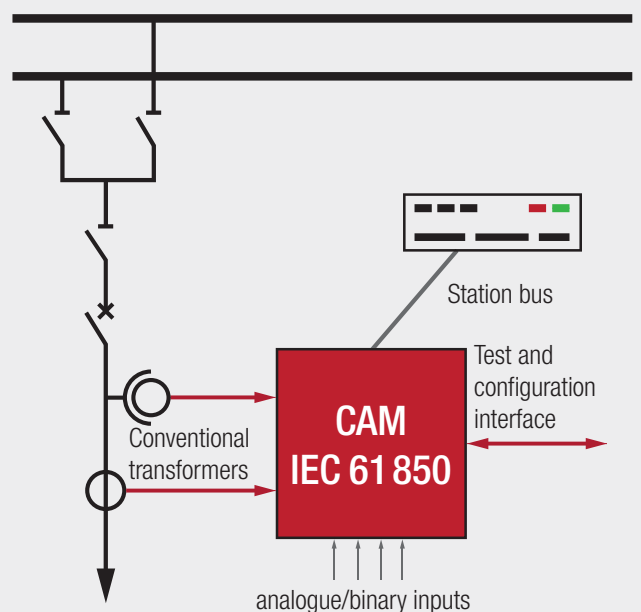



TECHNICAL DATA

Rated frequency: 50/60 Hz
 Measurement TRMS: Up to the 63rd harmonic
 Measurement category: 300 V CATIII, 600 V CATII

CURRENT MEASUREMENT

Rated current: 1 A (+ 20 %), 1 A (+ 100 %),
 5 A (+ 20 %), 5 A (+ 100 %)
 Overriding max.: 10 A (sinusoidal)
 Consumption: $\leq I^2 \times 0.01 \Omega$ per phase
 Thermal ratings: 12 A continuous
 100 A, 10 x 1 s, interval 100 s

Instead of current inputs the version for Rogowski coils provides voltage inputs of nominal 5 V (max. 10 V).

VOLTAGE MEASUREMENT

Rated voltage: 57.7 ... 400 V_{LN}, 100 ... 693 V_{LL}
 Overriding max.: 600 V_{LN}, 1040 V_{LL} (sinusoidal)
 Consumption: $\leq U^2/3 M\Omega$ per phase
 Input impedance: 3 M Ω per phase
 Thermal ratings: 480 V_{LN}, 832 V_{LL} continuous
 600 V_{LN}, 1040 V_{LL}, 10 x 10 s, interval 10 s
 800 V_{LN}, 1386 V_{LL}, 10 x 1 s, interval 10 s

TYPES OF CONNECTION

Single-phase, 1L
 Split phase (2 phase system), 2L
 3-wire system, balanced load, 3Lb
 3-wire system, unbalanced load, 3Lu
 3-wire system, unbalanced load (Aron), 3Lu.A
 4-wire system, balanced load, 4Lb
 4-wire system, unbalanced load, 4Lu
 4-wire system, unbalanced load (Open-Y), 4Lu.O

BASIC ACCURACY UNDER REFERENCE CONDITIONS IEC/EN 60 688

Voltage, current: $\pm 0.1 \%$ FS a)
 Power: $\pm 0.2 \%$ FS b)
 Power factor: $\pm 0.1^\circ$
 Frequency: ± 0.01 Hz
 Voltage unbalance U: $\pm 0.2 \%$
 Harmonics: $\pm 0.5 \%$
 THD Voltage: $\pm 0.5 \%$
 TDD Current: $\pm 0.5 \%$
 Active energy: Class 1 / EN 62 053-21 (direct connection)
 Active energy: Class 2 / EN 62 053-21 (transformer connection)
 Reactive energy: Class 2 / EN 62 053-23

a) FS: Maximum value of the input configuration (Full Scale)
 b) FS: FS-Voltage x FS-Current

POWER SUPPLY

Option 1
 AC, 50 - 400 Hz: 100 ... 230 V $\pm 15 \%$
 DC: 100 ... 230 V $\pm 15 \%$
 Consumption: ≤ 10 W resp. ≤ 20 VA
 Option 2
 DC: 24 ... 60 V $\pm 15 \%$
 Consumption: ≤ 10 W

INTERFACES

Configuration, measurement acquisition

Modbus connection (plug-in screw terminals 1, 2, 3)

Protocol: Modbus RTU
 Physics: RS-485, max. 1200 m (4000 ft)
 Baudrate: configurable 1.2 till 115.2 kBaud
 Number of bus stations: ≤ 32

USB connection (USB Mini-B, 5 contacts)

Protocol: USB 2.0

BASIC MEASURED QUANTITY

MEASURED QUANTITY	PRESENT	MAX	MIN	1L	2L	3LB	3LU	3LU.A	4LB	4LU	4LU.O
Voltage	U	•	•	•	✓	✓			✓		
Voltage	U1N	•	•	•	✓					✓	✓
Voltage	U2N	•	•	•	✓					✓	✓
Voltage	U3N	•	•	•						✓	✓
Voltage	U12	•	•	•		✓	✓	✓		✓	✓
Voltage	U23	•	•	•		✓	✓	✓		✓	✓
Voltage	U31	•	•	•		✓	✓	✓		✓	✓
Voltage	UNE	•	•		✓					✓	✓
Current	I	•	•		✓	✓			✓		
Current	I1	•	•		✓		✓	✓		✓	✓
Current	I2	•	•		✓		✓	✓		✓	✓
Current	I3	•	•				✓	✓		✓	✓
I-Bimetal 1-60 min	IB	•	•	✓		✓			✓		
I1-Bimetal 1-60 min	IB1	•	•		✓		✓	✓		✓	✓
I2-Bimetal 1-60 min	IB2	•	•		✓		✓	✓		✓	✓
I3-Bimetal 1-60 min	IB3	•	•				✓	✓		✓	✓
Neutral current	IN	•	•		✓					✓	✓
Active power Σ	P	•	•		✓	✓	✓	✓	✓	✓	✓
Active power	P1	•	•		✓					✓	✓
Active power	P2	•	•		✓					✓	✓
Active power	P3	•	•							✓	✓
Reactive power Σ	Q	•	•		✓	✓	✓	✓	✓	✓	✓
Reactive power	Q1	•	•		✓					✓	✓
Reactive power	Q2	•	•		✓					✓	✓
Reactive power	Q3	•	•							✓	✓
Apparent power Σ	S	•	•		✓	✓	✓	✓	✓	✓	✓
Apparent power	S1	•	•		✓					✓	✓
Apparent power	S2	•	•		✓					✓	✓
Apparent power	S3	•	•							✓	✓
Frequency	F	•	•	•	✓	✓	✓	✓	✓	✓	✓
Active power factor Σ	PF	•			✓	✓	✓	✓	✓	✓	✓
Active power factor	PF1	•			✓					✓	✓
Active power factor	PF2	•			✓					✓	✓
Active power factor	PF3	•								✓	✓
PF Σ incoming ind.				•	✓	✓	✓	✓	✓	✓	✓
PF Σ incoming cap.				•	✓	✓	✓	✓	✓	✓	✓
PF Σ outgoing ind.				•	✓	✓	✓	✓	✓	✓	✓
PF Σ outgoing cap.				•	✓	✓	✓	✓	✓	✓	✓
Reactive power factor Σ	QF	•			✓	✓	✓	✓	✓	✓	✓
Reactive power factor	QF1	•			✓					✓	✓
Reactive power factor	QF2	•			✓					✓	✓
Reactive power factor	QF3	•								✓	✓
LF power factor Σ	LF	•			✓	✓	✓	✓	✓	✓	✓
LF power factor	LF1	•			✓					✓	✓
LF power factor	LF2	•			✓					✓	✓
LF power factor	LF3	•								✓	✓
(U1N+U2N) / 2	Um	•			✓						
(U1N+U2N+U3N) / 3	Um	•								✓	✓
(U12+U23+U31) / 3	Um	•					✓	✓			
(I1+I2) / 2	Im	•			✓						
(I1+I2+I3) / 3	Im	•						✓	✓	✓	✓

ENERGY METERS (HIGH AND LOW TARIFF)

ACTIVE ENERGY	Incoming	Outgoing		
REACTIVE ENERGY	Incoming	Outgoing	Inductive	Capacitive



I/O-INTERFACE

RELAYS

Contacts: Changeover contact
Load capacity: 250 V AC, 2 A, 500 VA
30 V DC, 2 A, 60 W

ANALOG OUTPUTS

active
Linearization: Linear, quadratic, kinked
Range: 0/4...20 mA (24 mA max.), unipolar
or
± 20 A (24 mA max.), bipolar
Accuracy: ± 0.1 % of 20 mA
Burden: ≤ 500 Ω (max. 10 V / 20 mA)
Burden influence: ≤ 0.1 %
Residual ripple: ≤ 0.2 %
Galvanic isolation: From all other connections
(connected within group of terminals)

ANALOG INPUTS

Range: 0/4...20 mA (24 mA max.) unipolar
Accuracy: ± 0.1 % von 20 mA
Input resistance: < 40 Ω
Galvanic isolation: From all other connections
(connected within group of terminals)

DIGITAL INPUTS/OUTPUTS

Via software configurable as passive inputs or outputs
Inputs (acc. EN 61 131-2 DC 24V Type 3):
Rated voltage: 12/24 V DC (30 V max.)
Input current: < 7.0 mA
Counting frequency (S0): ≤ 50 Hz
Logical ZERO: – 3 till + 5 V
Logical ONE: 8 till 30 V
Switching limit: approx. 6.5 V / 2.6 mA

Outputs (partly acc. EN 61 131-2):
Rated voltage: 12/24 V DC (30 V max.)
Rated current: 50 mA (60 mA max.)
Switching frequency (S0): ≤ 20 Hz
Leakage current: 0.01 mA
Voltage drop: < 3 V
Load capacity: 400 Ω ... 1 MΩ
Fuse: Self-regulating

DIGITAL INPUTS 125 V DC

Rated voltage: 48/125 V DC (157 V max.)
Input current: < 2.5 mA
Counting frequency (S0): ≤ 50 Hz
Logical ZERO: – 6 till + 20 V
Logical ONE: 30 till 157 V
Switching limit: approx. 25 V / 0.8 mA

INTERNAL CLOCK (RTC)

Accuracy: ± 2 minutes / month (15 till 30 °C),
trimmable via PC software
Synchronisation via: Measurement input, HV-input,
synchronization pulse
Running reserve: > 10 years

MECHANICAL ATTRIBUTES

Orientation: Any
Housing material: Polycarbonate (Makrolon)
Flammability class: V-0 acc. UL94, self-extinguishing,
non-dripping, free of halogen
Weight: 500 g

SYSTEM ANALYSIS QUANTITIES

MEASURED QUANTITY		PRESENT	MAX	1L	2L	3LB	3LU	3LU.A	4LB	4LU	4LU.0
Voltage unbalance	unb. U	•	•							✓	✓
THD voltage	THD.U1N	•	•	✓	✓				✓	✓	✓
THD voltage	THD.U2N	•	•		✓					✓	✓
THD voltage	THD.U3N	•	•							✓	✓
THD voltage	THD.U12	•	•			✓	✓	✓			
THD voltage	THD.U23	•	•			✓	✓	✓			
THD voltage	THD.U31	•	•			✓	✓	✓			
TDD current	TDD.I1	•	•	✓	✓	✓	✓	✓	✓	✓	✓
TDD current	TDD.I2	•	•		✓		✓	✓		✓	✓
TDD current	TDD.I3	•	•				✓	✓		✓	✓
Harmonics	H2-50.U1	•	•	✓	✓				✓	✓	✓
Harmonics	H2-50.U2	•	•		✓					✓	✓
Harmonics	H2-50.U3	•	•							✓	✓
Harmonics	H2-50.U12	•	•			✓	✓	✓			
Harmonics	H2-50.U23	•	•			✓	✓	✓			
Harmonics	H2-50.U31	•	•			✓	✓	✓			
Harmonics	H2-50.I1	•	•	✓	✓	✓	✓	✓	✓	✓	✓
Harmonics	H2-50.I2	•	•		✓		✓	✓		✓	✓
Harmonics	H2-50.I3	•	•				✓	✓		✓	✓

THD U (Total Harmonic Distortion): Harmonic content related to the fundamental of the RMS value of voltage.

TDD I (Total Demand Distortion): Harmonic content related to the fundamental of the RMS value of the rated current.

DIMENSIONAL DRAWING

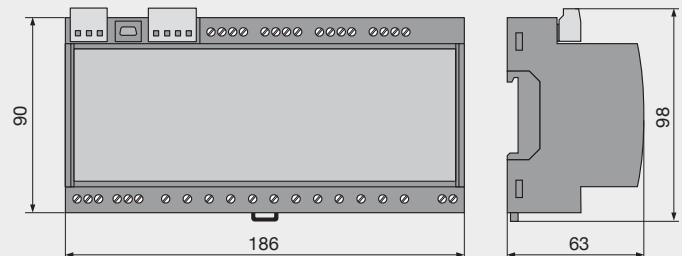

SINEAX CAM in housing clipped onto a top-hat rail (35 x 15 mm or 35 x 7.5 mm). Terminals partly pluggable.

AMBIENT CONDITIONS, GENERAL INFORMATION

Operating temperature: – 10...15...30...55 °C
Storage temperature: – 25 till + 70 °C
Variations due to
ambient temperature: 0.5 x basic accuracy per 10 K
Long term drift: 0.2 x basic accuracy per year
Others: Usage group II according IEC/EN 60 688
Relative humidity: < 95 % no condensation
Altitude: ≤ 2000 m max.

Indoor use statement!

**VIBRATION WITHSTAND** (acc. EN 60 068-2-6)

Acceleration:	± 5g
Frequency range:	10 ... 150 ... 10Hz, rate of frequency sweep: 1 Octave/Minute
Number of cycles:	10 in each of the three axes
Result:	No faults occurred, no loss of accuracy and no problems with the snap fastener

SECURITY

The current inputs are galvanically isolated from each other.

Protection class:	II (protective insulation, voltage inputs via protective impedance)
Pollution degree:	2
Protection:	IP40, housing (test wire, IEC/EN 60 529) IP20, Terminals (test finger, IEC/EN 60 529)
Measurement category:	CAT III (at ≤ 300V versus earth) CAT II (at > 300V versus earth)
Rated voltage (versus earth):	Power supply: 265 V AC Relays: 250 V AC I/O's: 30 V DC (Low level) 264 V AC (HV input)
Test voltages:	DC, 1 min., acc. IEC/EN 61 010-1 4920 V DC, power supply versus inputs U I, bus, USB, I/O's, relays 4920 V DC, Inputs U versus relays, HV-Input 3130 V DC, Inputs U versus inputs I, Bus, USB, low level I/O's 4920 V DC, Inputs I versus bus, USB, I/O's, relays 4690 V DC, Inputs I versus inputs I 4920 V DC, Relay versus relay 4250 V DC, Relay versus bus, USB, I/O's



APPLIED STANDARDS AND REGULATIONS

IEC/EN 61 010-1	Safety regulations for electrical measuring, control and laboratory equipment
IEC/EN 60 688	Electrical measuring transducers for converting AC electrical variables into analog and digital signals
DIN 40 110	AC quantities
IEC/EN 60 068-2-1/-2/-3/-6/-27:	Ambient tests -1 Cold, -2 Dry heat, -3 Damp heat, -6 Vibration, -27 Shock
IEC/EN 60 529	Protection types by case
IEC/EN 61 000-6-2 / 61 000-6-4:	Electromagnetic compatibility (EMC) Generic standard for industrial environments
IEC/EN 61 131-2	Programmable controllers – Equipment, requirements and tests (Digital inputs/outputs 12/24V DC)
IEC/EN 61 326	Electrical equipment for measurement, control and laboratory use – EMC requirements
IEC/EN 62 053-31	Pulse output devices for electromechanical and electronic meters (two wires only)
UL94	Tests for flammability of plastic materials for parts in devices and appliances

ORDER CODE

SINEAX CAM, PROGRAMMABLE, MODBUS INTERFACE, USB	CAM -
1. BASIC DEVICE CAM, FOR TOP-HAT RAIL MOUNTING	
Without display	1
With graphic display	2
Without display, with Rogowski current inputs (3V)	3
With graphic display and Rogowski current inputs (3V)	4
Without display, with Rogowski current inputs (4.5V)	5
With graphic display and Rogowski current inputs (4.5V)	6
Without display, with Rogowski current inputs (6V)	7
With graphic display and Rogowski current inputs (6V)	8
Without display, with Rogowski current inputs (9V)	9
With graphic display and Rogowski current inputs (9V)	A
2. INPUT FREQUENCY RANGE	
45 ... 50/60 ... 65 Hz	1
10 ... 50/60 ... 70 Hz	2
10 ... 50/60 ... 140 Hz	3
3. POWER SUPPLY	
Nominal range 100 ... 230 V AC/DC	1
Nominal range 24 ... 60 V DC	2
4. I/O-MODUL 1 (TERMINALS 41-44)	
Not used	0
2 analogue outputs, unipolar (0/4...20 mA)	1
2 analogue inputs (0/4...20 mA)	2
3 digital outputs or 3 digital inputs 24 V DC	3
2 analogue outputs, bipolar (± 20 mA)	5
5. I/O-MODUL 2 (TERMINALS 51-54)	
Not used	0
2 analogue output, unipolar (0/4...20 mA)	1
2 analogue inputs (0/4...20 mA)	2
3 digital outputs or 3 digital inputs 24 V DC	3
2 analogue outputs, bipolar (± 20 mA)	5
6. I/O-MODUL 3 (TERMINALS 61-64)	
Not used	0
2 analogue output, unipolar (0/4...20 mA)	1
2 analogue inputs (0/4...20 mA)	2
3 digital outputs or 3 digital inputs 24 V DC	3
2 Analogausgänge, bipolar (± 20 mA)	5
7. I/O-MODUL 4 (TERMINALS 71-74)	
Not used	0
2 analogue output, unipolar (0/4...20 mA)	1
2 analogue inputs (0/4...20 mA)	2
3 digital outputs or 3 digital inputs 24 V DC	3
2 analogue inputs, bipolar (± 20 mA)	5
3 digital inputs 125 V DC	6
8. TEST CERTIFICATE	
without	0
Test certificate in german	D
Test certificate in english	E
9. OPTION DATA LOGGER	
Without data logger	0
With data logger	1
10. OPTION LISTS	
Without alarm, event, operator list	0
With alarm, event, operator list	1
11. BUS INTERFACE	
Without	0
Ethernet, Modbus/TCP protocol	1
Ethernet, IEC 61850 protocol	2

GMC INSTRUMENTS

 **GOSSEN METRAWATT**
 **CAMILLE BAUER**

Camille Bauer Metrawatt AG
Aargauerstrasse 7 ■ 5610 Wohlen ■ Switzerland
TEL +41 56 618 21 11 ■ FAX +41 56 618 21 21

www.camillebauer.com ■ info@cbmag.com

